

DICOM Conformance Statement

iCT, iCT-SP v4.1.10



- This page is left intentionally empty -

1. DICOM Conformance Statement Overview

This version of the DICOM Conformance Statement applies to the iCT, iCT-SP scanners running on the iPatient (4.x) platform. The iPatient (4.x) platform is available across the iCT Elite, iCT TVI, iCT, iCT SP scanners.

The systems provides the following DICOM data exchange features:

- Store DICOM Images sent from a Workstation or PACS
- Transfer DICOM Images to a Workstation or PACS
- Query/Retrieve a Workstation or PACS for a list of entries representing Series of DICOM Images
- Query/Retrieve support to let a remote system query for a list of entries representing Series of DICOM Images
- Query a HIS/RIS for a MWL
- Update a remote system with information about Performed Procedure Steps (MPPS)
- Store DICOM Images on portable media (CD, CD-RW, DVD+/-R and DVD+/-RW disks)
- Read DICOM Images from a portable media
- Print Images (Grayscale and Color) on a DICOM Printer

The system is verified as DIN 6862-2 compliant.

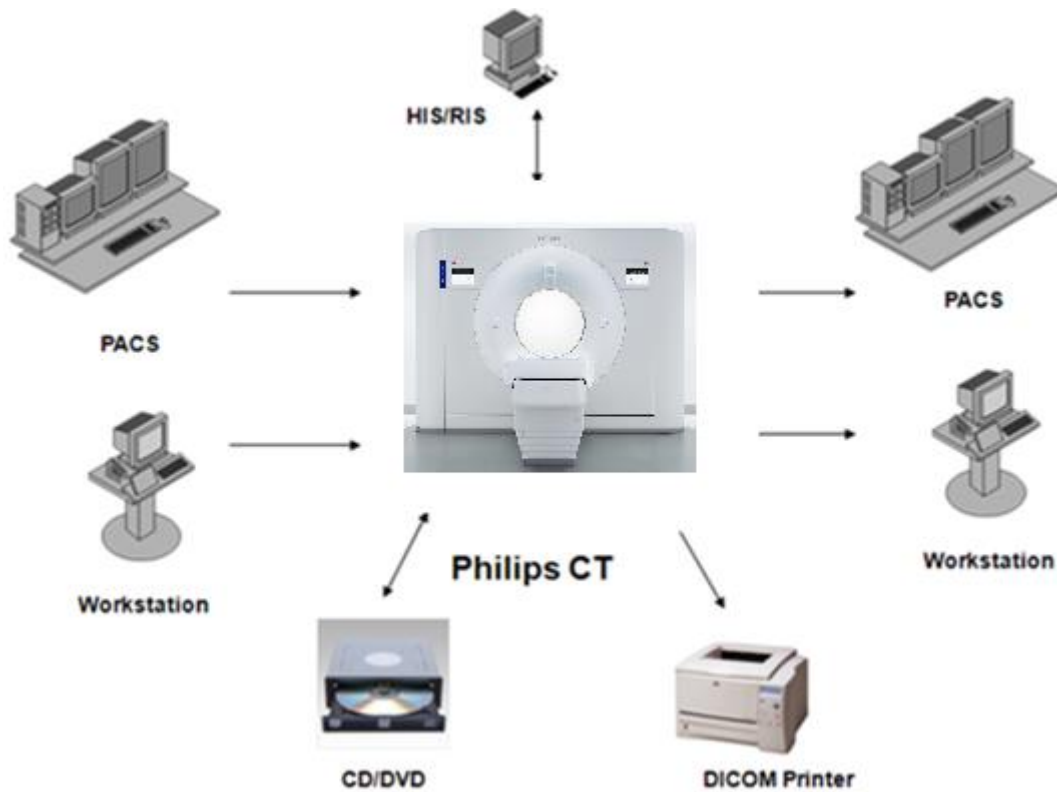

Figure 1: iCT, iCT-SP in a workflow

The following Table presents an overview of all network services and the applicable SOP Classes as provided by the iCT, iCT-SP CT scanner, where the first column specifies the used SOP Classes as named in PS 3.6 (Ref PS 3.6 Annex A) of the current DICOM Standard.

Table 1: Network Services

SOP Class		User of Service (SCU)	Provider of Service (SCP)	Display
Name	UID			
Other				
Verification SOP Class	1.2.840.10008.1.1	Yes	Yes	N/A
Print Management				
Basic Grayscale Print Management Meta SOP Class	1.2.840.10008.5.1.1.9	Yes	No	N/A
>Basic Film Box SOP Class	1.2.840.10008.5.1.1.2	Yes	No	N/A
>Basic Film Session SOP Class	1.2.840.10008.5.1.1.1	Yes	No	N/A
>Basic Grayscale Image Box SOP Class	1.2.840.10008.5.1.1.4	Yes	No	N/A
Basic Color Print Management Meta SOP Class	1.2.840.10008.5.1.1.18	Yes	No	N/A
>Basic Film Session SOP Class	1.2.840.10008.5.1.1.1	Yes	No	N/A
>Basic Film Box SOP Class	1.2.840.10008.5.1.1.2	Yes	No	N/A
>Basic Color Image Box SOP Class	1.2.840.10008.5.1.1.4.1	Yes	No	N/A
Query/Retrieve				
Study Root QR Information Model - FIND SOP Class	1.2.840.10008.5.1.4.1.2.2.1	Yes	Yes	N/A
Study Root QR Information Model - MOVE SOP Class	1.2.840.10008.5.1.4.1.2.2.2	Yes	Yes	N/A
Transfer				
Computed Radiography Image Storage SOP Class	1.2.840.10008.5.1.4.1.1.1	Yes	Yes	Yes
Digital X-Ray Image Storage - For Pres. SOP Class	1.2.840.10008.5.1.4.1.1.1.1	Yes	Yes	Yes
Digital X-Ray Image Storage - For Proc. SOP Class	1.2.840.10008.5.1.4.1.1.1.1.1	Yes	Yes	Yes
X-Ray Angiographic Image Storage SOP Class	1.2.840.10008.5.1.4.1.1.12.1	Yes	Yes	Yes
X-Ray Radiofluoroscopic Image Storage SOP Class	1.2.840.10008.5.1.4.1.1.12.2	Yes	Yes	Yes
CT Image Storage SOP Class	1.2.840.10008.5.1.4.1.1.2	Yes	Yes	Yes
Secondary Capture Image Storage SOP Class	1.2.840.10008.5.1.4.1.1.7	Yes	Yes	Yes
X-Ray Radiation Dose SR SOP Class	1.2.840.10008.5.1.4.1.1.88.67	Yes	Yes	Yes
General ECG Waveform Storage SOP Class	1.2.840.10008.5.1.4.1.1.9.1.2	Yes	Yes	Yes
MR Image Storage SOP Class	1.2.840.10008.5.1.4.1.1.4	Yes	Yes	Yes
Nuclear Medicine Image Storage SOP Class	1.2.840.10008.5.1.4.1.1.20	Yes	Yes	Yes
Digital Intraoral X-Ray Image Storage For Presentation SOP Class	1.2.840.10008.5.1.4.1.1.1.3	Yes	Yes	Yes
Digital Intraoral X-Ray Image Storage For Processing SOP Class	1.2.840.10008.5.1.4.1.1.1.3.1	Yes	Yes	Yes
Grayscale Presentation SOP Class	1.2.840.10008.5.1.4.1.1.11.1	Yes	Yes	Yes
Color Softcopy Presentation State Storage SOP Class	1.2.840.10008.5.1.4.1.1.11.2	Yes	Yes	Yes
Pseudo-Color Softcopy Presentation State Storage SOP Class	1.2.840.10008.5.1.4.1.1.11.3	Yes	Yes	Yes

SOP Class		User of Service (SCU)	Provider of Service (SCP)	Display
Name	UID			
Blending Softcopy Presentation State Storage SOP Class	1.2.840.10008.5.1.4.1.1.11.4	Yes	Yes	Yes
Real World Value Mapping Storage SOP Class	1.2.840.10008.5.1.4.1.1.67	Yes	Yes	Yes
Raw Data Storage SOP Class	1.2.840.10008.5.1.4.1.1.66	Yes	Yes	Yes
Key Object Selection Document Storage SOP Class	1.2.840.10008.5.1.4.1.1.88.59	Yes	Yes	Yes
Positron Emission Tomography Image Storage SOP Class	1.2.840.10008.5.1.4.1.1.128	Yes	Yes	Yes
Digital Mammography X-Ray Image Storage For Presentation SOP Class	1.2.840.10008.5.1.4.1.1.1.2	Yes	Yes	Yes
Digital Mammography X-Ray Image Storage For Processing SOP Class	1.2.840.10008.5.1.4.1.1.1.2.1	Yes	Yes	Yes
RT Image Storage SOP Class	1.2.840.10008.5.1.4.1.1.481.1	Yes	Yes	Yes
RT Dose Storage SOP Class	1.2.840.10008.5.1.4.1.1.481.2	Yes	Yes	Yes
RT Structure Set Storage SOP Class	1.2.840.10008.5.1.4.1.1.481.3	Yes	Yes	Yes
RT Plan Storage SOP Class	1.2.840.10008.5.1.4.1.1.481.5	Yes	Yes	Yes
Encapsulated PDF Storage SOP Class	1.2.840.10008.5.1.4.1.1.104.1	Yes	Yes	Yes
Spatial Registration Storage SOP Class	1.2.840.10008.5.1.4.1.1.66.1	Yes	Yes	Yes
Multiframe Single Bit Secondary Capture Image Storage SOP Class	1.2.840.10008.5.1.4.1.1.7.1	Yes	Yes	Yes
Multiframe Grayscale Byte Secondary Capture Image Storage SOP Class	1.2.840.10008.5.1.4.1.1.7.2	Yes	Yes	Yes
Multiframe Grayscale Word Secondary Capture Image Storage SOP Class	1.2.840.10008.5.1.4.1.1.7.3	Yes	Yes	Yes
Multiframe True Color Secondary Capture Image Storage SOP Class	1.2.840.10008.5.1.4.1.1.7.4	Yes	Yes	Yes
Workflow Management				
Modality Worklist Information Model - FIND SOP Class	1.2.840.10008.5.1.4.31	Yes	No	N/A
Modality Performed Procedure Step SOP Class	1.2.840.10008.3.1.2.3.3	Yes	No	N/A
Storage Commitment Push Model SOP Class	1.2.840.10008.1.20.1	Yes	No	N/A

Notes: Normally the system (SCU) requests only supported DICOM objects. All SOP Classes support the default ILE Transfer Syntax. All transfer Syntaxes are configurable in LAN Config.

Not supported is JPEG transfer syntax for all SOP classes if the IODs have no pixel data and for all non storage SOP classes.

For media the iCT, iCT-SP supports:

- FSC service for CD-R, CD-RW, DVD + R, DVD - R, DVD + RW, DVD - RW media
- FSR service for CD-R, CD-RW, DVD + R, DVD - R, DVD + RW, DVD - RW media

After data is written to CD/DVD, the CD/DVD is finalized; the finalized CD/DVD can now be read on mostly every CD/DVD reader.

All the Media Services supported by iCT, iCT-SP are shown in the next table.

Table 2: Media Services

Media Storage Application Profile	File-set Creator (FSC)	File-set Updater (FSU)	File-set Reader (FSR)
Compact Disk-Recordable			
CT/MR Studies on CD-R	Yes	No	Yes
General Purpose CD-R Interchange	Yes	No	Yes
DVD			
CT/MR Studies on DVD Media	Yes	No	Yes
General Purpose DVD Interchange with JPEG	Yes	No	Yes

2. Contents

- 1. DICOM Conformance Statement Overview 3
- 2. Contents 7
- 3. Introduction..... 9
 - 3.1. Revision History9
 - 3.2. Audience.....9
 - 3.3. Remarks.....9
 - 3.4. Definitions, Terms and Abbreviations10
 - 3.5. References.....11
- 4. Networking 12
 - 4.1. Implementation model.....12
 - 4.1.1. Application Data Flow12
 - 4.1.2. Functional Definition of AE's13
 - 4.1.2.1. Functional Definition of DICOM Manager.....13
 - 4.1.2.2. Functional Definition of Print Manager.....15
 - 4.1.3. Sequencing of Real World Activities15
 - 4.2. AE Specifications16
 - 4.2.1. DICOM Manager.....16
 - 4.2.1.1. SOP Classes16
 - 4.2.1.2. Association Policies17
 - 4.2.1.3. Association Initiation Policy18
 - 4.2.1.4. Association Acceptance Policy42
 - 4.2.2. Print Manager.....52
 - 4.2.2.1. SOP Classes.....52
 - 4.2.2.2. Association Policies52
 - 4.2.2.3. Association Initiation Policy53
 - 4.2.2.4. Association Acceptance Policy64
 - 4.3. Network Interfaces.....64
 - 4.3.1. Physical Network Interfaces.....64
 - 4.3.2. Additional Protocols64
 - 4.3.3. IPv4 and IPv6 Support64
 - 4.4. Configuration.....64
 - 4.4.1. AE Title/Presentation Address Mapping64
 - 4.4.1.1. Local AE Titles.....64
 - 4.4.1.2. Remote AE Title/Presentation Address Mapping65
 - 4.4.2. Parameters65
- 5. Media Interchange 67
 - 5.1. Implementation model.....67
 - 5.1.1. Application Data Flow Diagram67
 - 5.1.2. Functional Definitions of AE's.....67
 - 5.1.3. Sequencing of Real World Activities67
 - 5.1.4. File Meta Information for Implementation Class and Version.....68
 - 5.2. AE Specifications68
 - 5.2.1. Media - Specification.....68
 - 5.2.1.1. DICOM File Meta Information.....69
 - 5.2.1.2. Real-World Activities72
 - 5.3. Augmented and Private Application Profiles73
 - 5.4. Media Configuration73
- 6. Support of Character Sets 74

7. Security 75

7.1. Security Profiles 75

7.1.1. Security use Profiles 75

7.1.2. Security Transport Connection Profiles 75

7.1.3. Digital Signature Profiles 77

7.1.4. Media Storage Security Profiles 77

7.1.5. Attribute Confidentiality Profiles 77

7.1.6. Network Address Management Profiles 79

7.1.7. Time Synchronization Profiles 79

7.1.8. Application Configuration Management Profiles 79

7.1.9. Audit Trail Profiles 79

7.2. Association Level Security 80

7.3. Application Level Security 80

8. Annexes of application "iCT, iCT-SP" 81

8.1. IOD Contents 81

8.1.1. Created SOP Instance 81

8.1.1.1. List of created SOP Classes 83

8.1.2. Usage of Attributes from Received IOD 101

8.1.3. Attribute Mapping 101

8.1.4. Coerced/Modified fields 101

8.2. Data Dictionary of Private Attributes 102

8.3. Coded Terminology and Templates 102

8.3.1. Context Groups 102

8.3.2. Template Specifications 102

8.3.2.1. CT RADIATION DOSE SR IOD TEMPLATES 102

8.3.3. Private code definitions 108

8.4. Grayscale Image consistency 108

8.5. Standard Extended/Specialized/Private SOPs 108

8.5.1. Standard Extended/Specialized/Private SOP Instance 108

8.5.1.1. CT Image Storage SOP Class 108

8.5.1.2. Secondary Capture Image Storage SOP Class 108

8.5.1.3. General ECG Waveform Storage SOP Class 110

8.5.1.4. X-Ray Radiation Dose SR SOP Class 110

8.6. Private Transfer Syntaxes 110

3. Introduction

3.1. Revision History

The revision history provides dates and differences of the different releases.

Table 3: Revision History

Document Version	Date of Issue	Description of change
01	22-Jul-2019	First Approved Version
02	06-Feb-2020	Final version Version with DIN 6862-2 updates, supported character set
03	20-Nov-2020	Final Version Correction of manufacturer’s model name.
04	26-Apr-2023	Updated “General Series Module” Table by removing below attributes <ul style="list-style-type: none"> ○ Performed Procedure Step Start date (0040,0244) ○ Performed Procedure Step Start time (0040,0245) ○ Performed Procedure Step ID (0040,0253) ○ Performed Procedure Step Description (0040,0254)
05	18-Dec-2024	Updated document with Security Profiles and Audit Trail Profiles in Section 7. Security

3.2. Audience

This Conformance Statement is intended for:

- (Potential) customers
- System integrators of medical equipment
- Marketing staff interested in system functionality
- Software designers implementing DICOM interfaces

It is assumed that the reader is familiar with the DICOM standard.

3.3. Remarks

The DICOM Conformance Statement is contained in chapter 4 through 8 and follows the contents and structuring requirements of DICOM PS 3.2.

This DICOM Conformance Statement by itself does not guarantee successful interoperability of Philips equipment with non-Philips equipment. The user (or user's agent) should be aware of the following issues:

- **Interoperability**

Interoperability refers to the ability of application functions, distributed over two or more systems, to work successfully together. The integration of medical devices into an IT environment may require application functions that are not specified within the scope of DICOM. Consequently, using only the information provided by this Conformance Statement does not guarantee interoperability of Philips equipment with non-Philips equipment. It is the user's responsibility to analyze thoroughly the application requirements and to specify a solution that integrates Philips equipment with non-Philips equipment.

- **Validation**

Philips equipment has been carefully tested to ensure that the actual implementation of the DICOM interface corresponds with this Conformance Statement. Where Philips equipment is linked to non-Philips equipment, the first step is to compare the relevant Conformance Statements. If the Conformance Statements indicate that successful information exchange should be possible, additional

validation tests will be necessary to ensure the functionality, performance, accuracy and stability of image and image related data. It is the responsibility of the user (or user's agent) to specify the appropriate test suite and to carry out the additional validation tests.

• **New versions of the DICOM Standard**

The DICOM Standard will evolve in future to meet the user's growing requirements and to incorporate new features and technologies. Philips is actively involved in this evolution and plans to adapt its equipment to future versions of the DICOM Standard. In order to do so, Philips reserves the right to make changes to its products or to discontinue its delivery. The user should ensure that any non-Philips provider linking to Philips equipment also adapts to future versions of the DICOM Standard. If not, the incorporation of DICOM enhancements into Philips equipment may lead to loss of connectivity (in case of networking) and incompatibility (in case of media).

The user should ensure that any non-Philips provider linking to Philips equipment also adapts to future versions of the DICOM Standard. If not, the incorporation of DICOM enhancements into Philips equipment may lead to loss of connectivity (in case of networking) and incompatibility (in case of media)

3.4. Definitions, Terms and Abbreviations

Table 4: Definitions, Terms and Abbreviations

Abbreviation/Term	Explanation
AE	Application Entity
ANSI	American National Standard Institute
AP	Application Profile
BWLM	Basic Worklist Management
CD	Compact Disc
CD-R	CD-Recordable
CT	Computed Tomography
DICOM	Digital Imaging and Communications in Medicine
DIMSE	DICOM Message Service Element
DIMSE-C	DIMSE-Composite
DIMSE-N	DIMSE-Normalized
DIN	Deutsches Institut für Normung E.V.
DVD	Digital Versatile Disc
ELE	DICOM Explicit VR Little Endian
FSC	File-set Creator
FSR	File-set Reader
FSU	File-set Updater
GUI	Graphic User Interface
HIS	Hospital Information System
ILE	DICOM Implicit VR Little Endian
IOD	Information Object Definition
LanConfig	Service utility available on Ingenuity
MPPS	Modality Performed Procedure Step
MR	Magnetic Resonance
NEMA	National Electrical Manufacturers Association
NM	Nuclear Medicine
PDU	Protocol Data Unit

Abbreviation/Term	Explanation
P-ELE	Private CT Transfer Syntax - Explicit Little Endian
RIS	Radiology Information System
RT	Radiotherapy
RWA	Real-World Activity
SC	Secondary Capture
SCP	Service Class Provider
SCU	Service Class User
SOP	Service Object Pair
TCP/IP	Transmission Control Protocol/Internet Protocol
UID	Unique Identifier

3.5. References

[DICOM] Digital Imaging and Communications in Medicine, Parts 1 - 22 (NEMA PS 3.1- PS 3.22),
 National Electrical Manufacturers Association
 1300 North 17th Street
 Suite 900
 Arlington, Virginia 22209
 Internet: <https://www.dicomstandard.org/current>

4. Networking

This section contains the networking related services (vs. the media related ones).

4.1. Implementation model

The implementation model consists of three sections:

- The application data flow diagram, specifying the relationship between the Application Entities and the "external world" or Real-World Activities,
- A functional description of each Application Entity, and
- The sequencing constraints among them.

4.1.1. Application Data Flow

The system implements and provides DICOM services using the following Application Entities:

- DICOM-Manager
- Print-Manager

The iCT, iCT-SP scanner system consists of two Application Entities. The following figure shows the Networking application data flow as a functional overview of the iCT, iCT-SP system. As depicted in the Figure, the iCT, iCT-SP system incorporates the following functionality.

- DICOM Verification service (for both SCU and SCP).
- Storage of DICOM objects on a remote DICOM system.
- Commitment of stored DICOM objects on a remote DICOM system (Push Model).
- Querying for data on a remote DICOM system.
- Retrieval of DICOM objects from a remote DICOM system.
- Basic Worklist Management (BWLM).
- Implementation of Modality Performed Procedure Step (MPPS).
- Storage and Retrieval of DICOM objects per removable media.
- Printing of hardcopies on a remote DICOM printer.
- Query for data by a remote DICOM system.

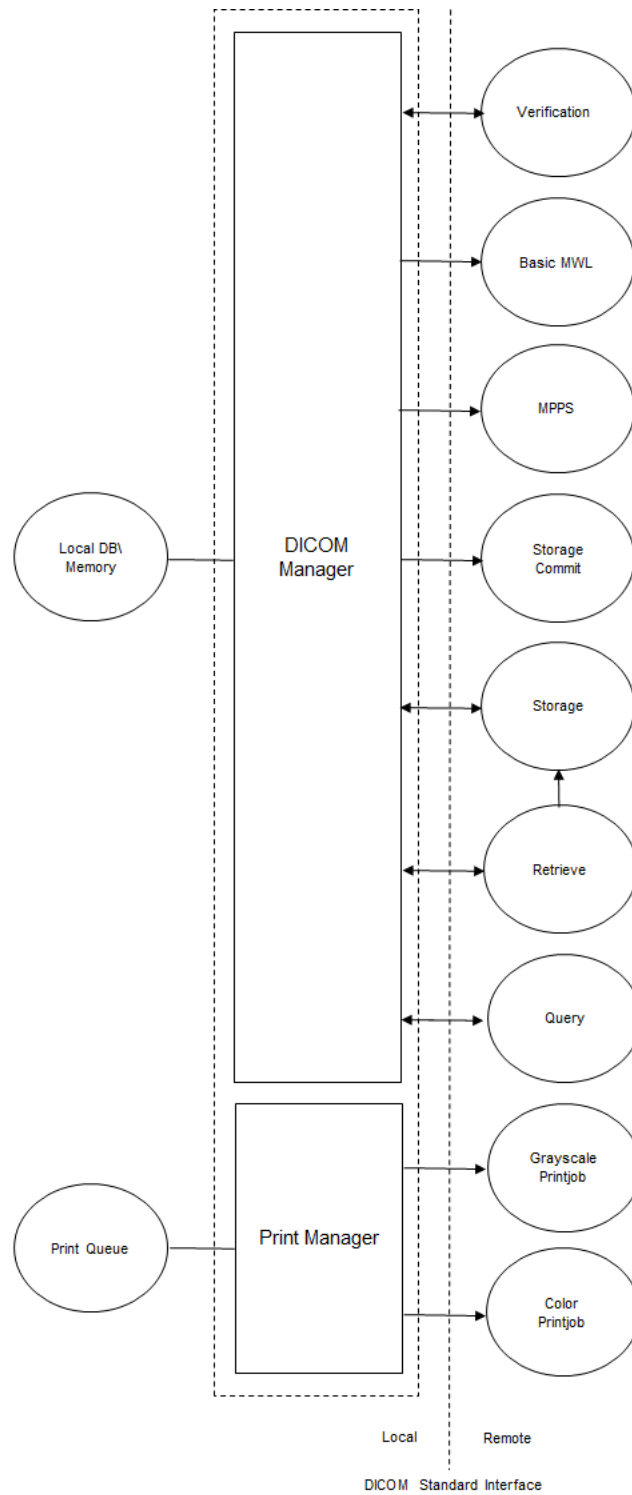

Figure 2: Network Data Flow Diagram

4.1.2. Functional Definition of AE’s

This section contains a functional definition for each individual local Application Entity.

4.1.2.1. Functional Definition of DICOM Manager

The DICOM Manager includes the following service classes.

Verification Service Class

The DICOM Manager provides the Verification service as SCU and SCP.

A remote SCU shall request an association with the DICOM Manager for Verification SOP class. After accepting the association the DICOM Manager shall receive and respond to the Verification request and release the association when requested.

The DICOM Manager can request an association to a remote node for Verification SOP class. After receiving the response for the Verification request from the remote SCP system, it releases the association.

Basic Worklist Management Service Class

The DICOM Manager uses the Basic Worklist Management service as SCU.

After initiating a worklist query the DICOM Manager requests an association with the configured remote Basic Worklist Management SCP. After accepting the association the DICOM Manager shall send the find request, wait for response, and then release the association.

The system shall be updated with the query results.

Modality Performed Procedure Step Service Class

The DICOM Manager as SCU uses the Modality Performed Procedure Step service class to report the status of a procedure step to the configured MPPS manager.

As soon as a study is selected on the scanner and the first acquisition is made, a MPPS N-CREATE message is sent with the status IN PROGRESS to the MPPS manager.

After a worklist is finished on the DICOM Manager scanner (indicated by finishing the study), a new association is opened with the MPPS manager and an N-SET message is sent with the status COMPLETED.

In case a performed procedure step is ended before all scheduled steps are finished, an MPPS N-SET message is sent to the MPPS Manager with status DISCONTINUED.

Storage Service

When performing a Storage Service Class (SCP), the DICOM Manager will receive images and store them into the system's local database. The same AE may be used (with a configurable different AE title) to access the local CD/DVD or different local hard disk folders.

Storage Commitment Service

The DICOM Manager is responsible to issue and support the storage commitment service as SCU.

The DICOM Manager establishes association with the specified AE title and sends storage commitment (N-ACTION) request using the push model. After that, it may accept storage commitment (N-EVENT-REPORT) requests on the same association or by establishing another association.

Query Retrieve Service

The DICOM Manager waits for another application to connect at the presentation address configured for its AE title. The DICOM Manager will accept associations with Presentation Contexts for Service Object Pair (SOP) classes for:

- Storage Service Classes (C-STORE)
- Query-Retrieve Service Class (C-MOVE and C-FIND only)
- Verification Service Classes.

When performing Query-Retrieve Service Class (C-FIND SCP), the DICOM Manager will query its local database according to the request's parameters, and will send the results to the issuer.

When performing Query-Retrieve Service Class (C-MOVE SCP), the DICOM Manager will issue a C-STORE (SCU) to the target AE for every image found according to the request.

Export Service

When an object is exported from the local database to an external device, the attributes will be preserved unless an Export Converter is applied.

4.1.2.2. Functional Definition of Print Manager

The Print-Manager is a Graphical User Interface (GUI) based application. It enables the user to print predefined images using the DICOM protocol. The user can specify as a printing destination one of several predefined printers. The user can also modify some of the printing parameters such as the film size and format.

4.1.3. Sequencing of Real World Activities

This section contains description of specific sequencing as well as potential constraints of Real-World Activities, including any applicable user interactions, as performed by the DICOM Manager.

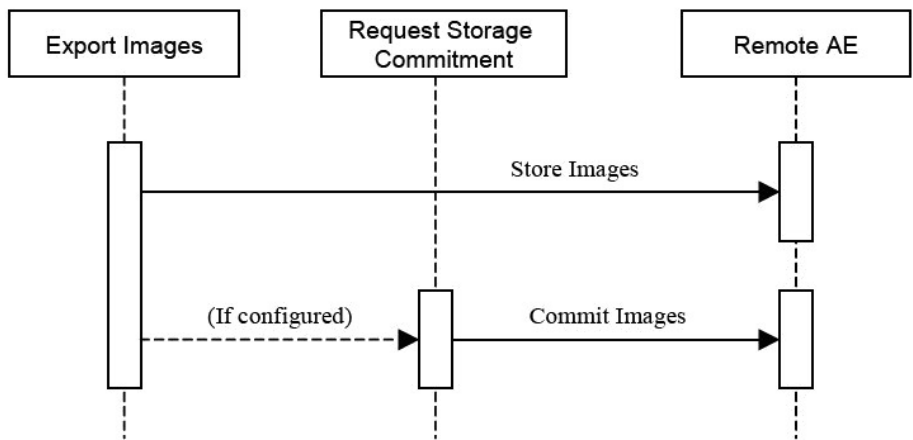

Figure 3: Sequencing for Export Images

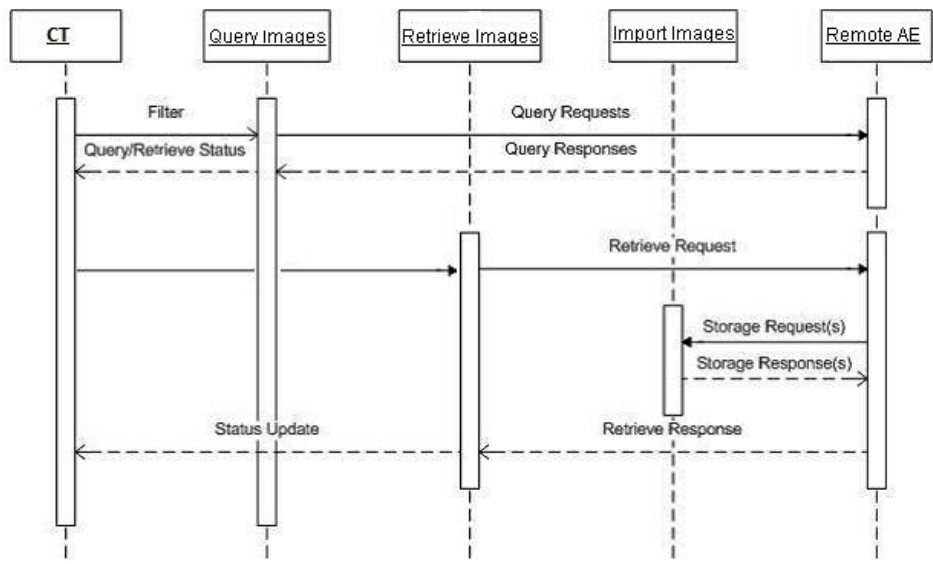

Figure 4: Sequencing for Retrieve Local Images

4.2. AE Specifications

This section in the DICOM Conformance Statement is a set of Application Entity specifications. There are as many of these subsections as there are different AE's in the implementation.

4.2.1. DICOM Manager

Details of this specific Application Entity is specified in this section.

4.2.1.1. SOP Classes

This Application Entity provides Standard Conformance to the following SOP Classes.

Table 5: SOP Classes for DICOM Manager

SOP Class Name	SOP Class UID	SCU	SCP
Verification SOP Class	1.2.840.10008.1.1	Yes	Yes
Storage Commitment Push Model SOP Class	1.2.840.10008.1.20.1	Yes	No
Modality Performed Procedure Step SOP Class	1.2.840.10008.3.1.2.3.3	Yes	No
Study Root QR Information Model - FIND SOP Class	1.2.840.10008.5.1.4.1.2.2.1	Yes	Yes
Study Root QR Information Model - MOVE SOP Class	1.2.840.10008.5.1.4.1.2.2.2	Yes	Yes
Modality Worklist Information Model - FIND SOP Class	1.2.840.10008.5.1.4.31	Yes	No
Computed Radiography Image Storage SOP Class	1.2.840.10008.5.1.4.1.1.1	Yes	Yes
Digital X-Ray Image Storage - For Pres. SOP Class	1.2.840.10008.5.1.4.1.1.1.1	Yes	Yes
Digital X-Ray Image Storage - For Proc. SOP Class	1.2.840.10008.5.1.4.1.1.1.1.1	Yes	Yes
X-Ray Angiographic Image Storage SOP Class	1.2.840.10008.5.1.4.1.1.12.1	Yes	Yes
X-Ray Radiofluoroscopic Image Storage SOP Class	1.2.840.10008.5.1.4.1.1.12.2	Yes	Yes
CT Image Storage SOP Class	1.2.840.10008.5.1.4.1.1.2	Yes	Yes
Secondary Capture Image Storage SOP Class	1.2.840.10008.5.1.4.1.1.7	Yes	Yes
X-Ray Radiation Dose SR SOP Class	1.2.840.10008.5.1.4.1.1.88.67	Yes	Yes
General ECG Waveform Storage SOP Class	1.2.840.10008.5.1.4.1.1.9.1.2	Yes	Yes
MR Image Storage SOP Class	1.2.840.10008.5.1.4.1.1.4	Yes	Yes
Nuclear Medicine Image Storage SOP Class	1.2.840.10008.5.1.4.1.1.20	Yes	Yes
Digital Intraoral X-Ray Image Storage For Presentation SOP Class	1.2.840.10008.5.1.4.1.1.1.3	Yes	Yes
Digital Intraoral X-Ray Image Storage For Processing SOP Class	1.2.840.10008.5.1.4.1.1.1.3.1	Yes	Yes
Grayscale Presentation SOP Class	1.2.840.10008.5.1.4.1.1.11.1	Yes	Yes
Color Softcopy Presentation State Storage SOP Class	1.2.840.10008.5.1.4.1.1.11.2	Yes	Yes
Pseudo-Color Softcopy Presentation State Storage SOP Class	1.2.840.10008.5.1.4.1.1.11.3	Yes	Yes
Blending Softcopy Presentation State Storage SOP Class	1.2.840.10008.5.1.4.1.1.11.4	Yes	Yes
Real World Value Mapping Storage SOP Class	1.2.840.10008.5.1.4.1.1.67	Yes	Yes
Raw Data Storage SOP Class	1.2.840.10008.5.1.4.1.1.66	Yes	Yes
Key Object Selection Document Storage SOP Class	1.2.840.10008.5.1.4.1.1.88.59	Yes	Yes
Positron Emission Tomography Image Storage SOP Class	1.2.840.10008.5.1.4.1.1.128	Yes	Yes
Digital Mammography X-Ray Image Storage For Presentation SOP Class	1.2.840.10008.5.1.4.1.1.1.2	Yes	Yes

SOP Class Name	SOP Class UID	SCU	SCP
Digital Mammography X-Ray Image Storage For Processing	1.2.840.10008.5.1.4.1.1.2.1	Yes	Yes
RT Image Storage SOP Class	1.2.840.10008.5.1.4.1.1.481.1	Yes	Yes
RT Dose Storage SOP Class	1.2.840.10008.5.1.4.1.1.481.2	Yes	Yes
RT Structure Set Storage SOP Class	1.2.840.10008.5.1.4.1.1.481.3	Yes	Yes
RT Plan Storage SOP Class	1.2.840.10008.5.1.4.1.1.481.5	Yes	Yes
Encapsulated PDF Storage SOP Class	1.2.840.10008.5.1.4.1.1.104.1	Yes	Yes
Spatial Registration Storage SOP Class	1.2.840.10008.5.1.4.1.1.66.1	Yes	Yes
Multiframe Single Bit Secondary Capture Image Storage	1.2.840.10008.5.1.4.1.1.7.1	Yes	Yes
Multiframe Grayscale Byte Secondary Capture Image Storage SOP Class	1.2.840.10008.5.1.4.1.1.7.2	Yes	Yes
Multiframe Grayscale Word Secondary Capture Image Storage	1.2.840.10008.5.1.4.1.1.7.3	Yes	Yes
Multiframe True Color Secondary Capture Image Storage	1.2.840.10008.5.1.4.1.1.7.4	Yes	Yes

Note: Any SOP specific behavior is documented later in the conformance statement in the applicable SOP specific conformance section.

4.2.1.2. Association Policies

Each AE specification contains a description of the general association establishment and acceptance policies of the AE.

With incoming association requests the system allows acceptance of a range of defined IP addresses which is configurable in the LanConfig application.

4.2.1.2.1 General

The DICOM standard application context is specified below.

Table 6: DICOM Application Context

Description	Value
Application Context Name	1.2.840.10008.3.1.1.1

4.2.1.2.2 Number of Associations

Table 7: Number of associations as an Association Initiator for this AE

Description	Value
Maximum number of simultaneous associations	“Not configurable” (limited to resource availability)

Table 8: Number of associations as an Association Acceptor for this AE

Description	Value
Maximum number of simultaneous associations	“Not configurable” (limited to resource availability)

4.2.1.2.3 Asynchronous Nature

The implementation supports negotiation of multiple outstanding transactions, along with the maximum number of outstanding transactions supported.

Table 9: Asynchronous nature as an Association Initiator for this AE

Description	Value
Maximum number of outstanding asynchronous transactions	1

4.2.1.2.4 Implementation Identifying Information

The value supplied for Implementation Class UID and version name are documented here.

Table 10: DICOM Implementation Class and Version for DICOM Manager

Implementation Class UID	1.3.46.670589.33.103.11
Implementation Version Name	EBW4.8 for CT

4.2.1.2.5 Communication Failure Handling

The behavior of the AE during communication failure is summarized in the next table.

Table 11: Communication Failure Behavior

Exception	Behavior	Comment
ARTIM Timeout	The system stops the ARTIM timer and closes the transport connection.	Configurable, minimum value = 1
Association Timeout	A release request is sent in order to close the association.	Configurable, minimum value = 1

4.2.1.3. Association Initiation Policy

The Application Entity will respond to a received Association rejection as shown in the next table.

Table 12: Association Rejection response

Result	Source	Reason/Diagnosis	Behavior
1 - rejected-permanent	1 - DICOM UL service-user	1 - no-reason-given	Association reject is logged and connection is closed
		2 - application-context-name-not supported	Association reject is logged and connection is closed
		3 - calling-AE-title-not-recognized	Association reject is logged and connection is closed
		7 - called-AE-title-not-recognized	Association reject is logged and connection is closed
	2 - DICOM UL service-provider (ACSE related function)	1 - no-reason-given	Association reject is logged and connection is closed
		2 - protocol-version-not-supported	Association reject is logged and connection is closed
3 - DICOM UL service-provider (Presentation related function)	1 - temporary-congestion	Association reject is logged and connection is closed	
	2 - local-limit-exceeded	Association reject is logged and connection is closed	
2 - rejected-transient	1 - DICOM UL service-user	1 - no-reason-given	Association reject is logged and connection is closed
		2 - application-context-name-not supported	Association reject is logged and connection is closed

Result	Source	Reason/Diagnosis	Behavior
		3 - calling-AE-title-not-recognized	Association reject is logged and connection is closed
		7 - called-AE-title-not-recognized	Association reject is logged and connection is closed
	2 - DICOM UL service-provider (ACSE related function)	1 - no-reason-given	Association reject is logged and connection is closed
		2 - protocol-version-not-supported	Association reject is logged and connection is closed
	3 - DICOM UL service-provider (Presentation related function)	1 - temporary-congestion	Association reject is logged and connection is closed
		2 - local-limit-exceeded	Association reject is logged and connection is closed

The behavior of the AE on receiving an Association abort is summarized in the next table.

Table 13: Association Abort Handling

Source	Reason/Diagnosis	Behavior
0 - DICOM UL service-user (initiated abort)	0 - reason-not-specified	Abort is logged and connection is closed.
2 - DICOM UL service-provider (initiated abort)	0 - reason-not-specified	Abort is logged and connection is closed.
	1 - unrecognized-PDU	Abort is logged and connection is closed.
	2 - unexpected-PDU	Abort is logged and connection is closed.
	4 - unrecognized-PDU-parameter	Abort is logged and connection is closed.
	5 - unexpected-PDU-parameter	Abort is logged and connection is closed.
	6 - invalid-PDU-parameter-value	Abort is logged and connection is closed.

The behavior of the AE for sending an association abort is summarized in next table.

Table 14: DICOM Association Abort Policies

Source	Reason/Diagnosis	Behavior
0 - DICOM UL service-user (initiated abort)	0 - reason-not-specified	Abort is logged and connection is closed.
2 - DICOM UL service-provider (initiated abort)	0 - reason-not-specified	Abort is logged and connection is closed.
	1 - unrecognized-PDU	
	2 - unexpected-PDU	
	4 - unrecognized-PDU parameter	
	5 - unexpected-PDU parameter	
	6 - invalid-PDU-parameter value	

4.2.1.3.1 (Real-World) Activity – Verification as SCU

4.2.1.3.1.1 Description and Sequencing of Activities

DICOM Manager initiates an C-ECHO when the user points to one of the icons in the devices tool-bar in the UI, clicks the right mouse button and selects "Verify Connection" operation.

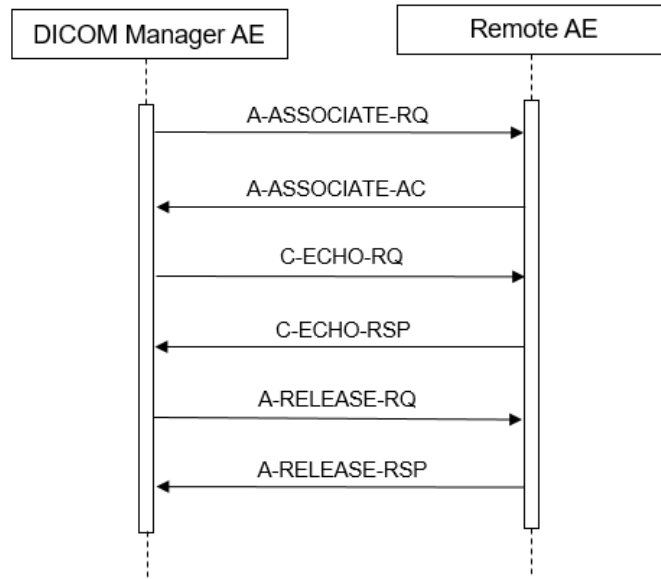

Figure 5: (Real World) Activity - Verification as SCU

4.2.1.3.1.2 Proposed Presentation Contexts

Each time an association is initiated, the association initiator proposes a number of presentation contexts supported for the association. The association will be closed immediately upon receiving the response.

The presentation contexts proposed by DICOM Manager for (Real-World) Activity - Verification as SCU are defined in the following table.

Table 15: Proposed Presentation Contexts for (Real-World) Activity – Verification as SCU

Presentation Context Table					
Abstract Syntax		Transfer Syntax		Role	Extended Negotiation
Name	UID	Name List	UID List		
Verification SOP Class	1.2.840.10008.1.1	Explicit VR Little Endian	1.2.840.10008.1.2.1	SCU	None
		Implicit VR Little Endian	1.2.840.10008.1.2		

Note: The default supported Transfer Syntax is ILE. ELE has preference over ILE.

4.2.1.3.1.3 SOP Specific Conformance for Verification SOP Class

This section and sub-section includes the manufacturer SOP and Dataset specific information as well the status codes and their corresponding behavior.

DICOM Manager provides standard conformance to the DICOM 3.0.

4.2.1.3.1.3.1 Dataset Specific Conformance for Verification C-ECHO SCU

Detail regarding the Dataset Specific response behavior will be reported in this section.

This part of the section includes the dataset specific behavior, i.e. error codes, error and exception handling, time-outs, etc.

Table 16: Status Response

Service Status	Error Code	Further Meaning	Behavior
Success	0000	Success	The SCU has successfully send C-ECHO.

Service Status	Error Code	Further Meaning	Behavior
Other than Success	<xxxx>	Problems with sending the C-ECHO	The SCU failed to send the C-ECHO; user is notified.

4.2.1.3.2 (Real-World) Activity – Modality Worklist as SCU

4.2.1.3.2.1 Description and Sequencing of Activities

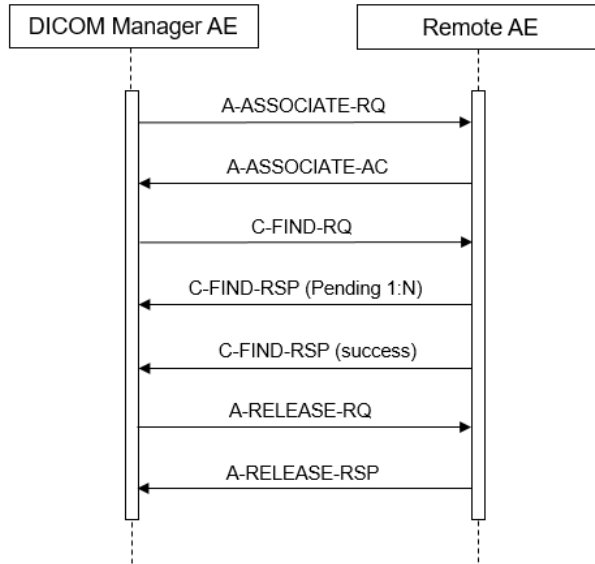

Figure 6: (Real World) Activity - Modality worklist As SCU

4.2.1.3.2.2 Proposed Presentation Contexts

The presentation contexts are defined in next table.

Table 17: Proposed Presentation Contexts for (Real-World) Activity – Modality worklist As SCU

Presentation Context Table					
Abstract Syntax		Transfer Syntax		Role	Extended Negotiation
Name	UID	Name List	UID List		
Modality Worklist Information Model - FIND SOP Class	1.2.840.10008.5.1.4.31	Explicit VR Little Endian	1.2.840.10008.1.2.1	SCU	None
		Implicit VR Little Endian	1.2.840.10008.1.2		

4.2.1.3.2.3 SOP Specific Conformance for Modality Worklist Information Model - FIND SOP Class

This section and sub-section include the manufacturer SOP and Dataset specific information as well the status codes and their corresponding behavior.

4.2.1.3.2.3.1 Dataset Specific Conformance for Modality Worklist Information Model - FIND SOP Class C-FIND-SCU

Detail regarding the Dataset Specific response behavior will be reported in this section.

The table below should be read as follows:

Attribute Name: Attributes supported to build a Modality Worklist Request Identifier.
 Tag: DICOM tag for this attribute.

- VR: DICOM VR for this attribute.
- M: Matching Keys. An "X" indicates that this attribute is used for (automatic) Worklist Update.
- R: Return Keys. An "X" will indicate that this attribute will be supplied as a Return Key with zero length for Universal Matching.
- Q: Interactive Query Key. An "X" will indicate that Worklist attribute can be used as matching key.
- D: Displayed Keys. An "X" indicates that this Worklist attribute is displayed to the user during a patient registration dialog.
- IOD: An "X" indicates that this Worklist attribute is included into all object Instances created during performance of the related Procedure Step.
- Type of matching: The following types of matching exists:
 - Single Value Matching
 - List of UID Matching
 - Wild Card Matching
 - Range Matching
 - Sequence Matching
 - Universal Matching

Table 18: Worklist Request Identifier

Attribute Name	Tag	VR	M	R	Q	D	IOD	Type of Matching	Comment
Patient Identification Module									
Other Patient IDs	0010,1000	LO		X					
Patient ID	0010,0020	LO	X	X	X	X	X	Single Value, Wildcard, Universal	
Patient's Name	0010,0010	PN	X	X	X	X	X	Single Value, Wildcard, Universal	
Patient Demographic Module									
Confidentiality Constraint on Patient Data Description	0040,3001	LO		X					
Ethnic Group	0010,2160	SH		X					
Patient Comments	0010,4000	LT		X			X		
Patient's Birth Date	0010,0030	DA		X	X	X	X	Universal	
Patient's Sex	0010,0040	CS		X	X	X	X	Universal	
Patient's Size	0010,1020	DS		X					
Patient's Weight	0010,1030	DS		X		X	X	Universal	
Patient's Primary Language Code Sequence	0010,0101	SQ		X					
>Code Value	0008,0100	SH		X					
>Coding Scheme Designator	0008,0102	SH		X					
>Code Meaning	0008,0104	LO		X					
Patient Medical Module									
Additional Patient History	0010,21B0	LT		X			X		
Allergies	0010,2110	LO		X					

Attribute Name	Tag	VR	M	R	Q	D	IOD	Type of Matching	Comment
Medical Alerts	0010,2000	LO		X					
Patient State	0038,0500	LO		X					
Pregnancy Status	0010,21C0	US		X					
Smoking Status	0010,21A0	CS		X					
Special Needs	0038,0050	LO		X		X			
Visit Relationship Module									
Referenced Patient Sequence	0008, 1120	SQ		X					
>Referenced SOP Class UID	0008, 1150	UI		X					
>Referenced SOP Instance UID	0008, 1155	UI		X					
Visit Identification Module									
Admission ID	0038,0010	LO		X					
Visit Status Module									
Current Patient Location	0038, 0300	LO		X				Universal	
Visit Comments	0038, 4000	LT		X				Universal	
Visit Admission Module									
Admitting Diagnoses Description	0008,1080	LO		X					
Referring Physician's Address	0008,0092	ST		X					
Referring Physician's Telephone Numbers	0008,0094	SH		X					
Route of Admissions	0038,0016	LO		X					
Admitting Diagnoses Code Sequence	0008,1084	SQ		X					
>Code Value	0008,0100	SH		X					
>Coding Scheme Designator	0008,0102	SH		X					
>Code Meaning	0008,0104	LO		X					
SOP Common Module									
Specific Character Set	0008,0005	CS		X					
Scheduled Procedure Step Module									
Scheduled Procedure Step Sequence	0040,0100	SQ		X					
>Modality	0008,0060	CS	X		X	X	X	Single Value	
>Pre-Medication	0040,0012	LO		X					
>Requested Contrast Agent	0032,1070	LO		X					
>Scheduled Performing Physician's Name	0040,0006	PN		X					

Attribute Name	Tag	VR	M	R	Q	D	IOD	Type of Matching	Comment
>Scheduled Procedure Step Description	0040,0007	LO		X			X		
>Scheduled Procedure Step ID	0040,0009	SH		X			X		
>Scheduled Procedure Step Start Date	0040,0002	DA	X	X	X	X		Range, Single Value	
>Scheduled Procedure Step Start Time	0040,0003	TM		X					
>Scheduled Procedure Step Status	0040,0020	CS		X					
>Scheduled Station AE Title	0040,0001	AE	X					Single Value	
>Scheduled Station Name	0040,0010	SH		X					
>Scheduled Protocol Code Sequence	0040,0008	SQ		X			X		
>>Code Meaning	0008,0104	LO		X			X		
>>Code Value	0008,0100	SH		X			X		
>>Coding Scheme Designator	0008,0102	SH		X			X		
Requested Procedure Module									
Names of Intended Recipients of Results	0040,1010	PN		X					
Patient Transport Arrangements	0040,1004	LO		X					
Requested Procedure Comments	0040,1400	LT		X					
Requested Procedure Description	0032,1060	LO		X					
Requested Procedure ID	0040,1001	SH	X	X	X		X	Universal	
Requested Procedure Priority	0040,1003	SH		X					
Study Instance UID	0020,000D	UI		X			X		
Referenced Study Sequence	0008,1110	SQ		X			X		
>Referenced SOP Class UID	0008,1150	UI		X			X		
>Referenced SOP Instance UID	0008,1155	UI		X			X		
Requested Procedure Code Sequence	0032,1064	SQ		X					
>Code Meaning	0008,0104	LO		X					
>Code Value	0008,0100	SH		X					

Attribute Name	Tag	VR	M	R	Q	D	IOD	Type of Matching	Comment
>Coding Scheme Designator	0008,0102	SH		X					
Imaging Service Request Module									
Accession Number	0008,0050	SH	X	X	X	X	X	Universal	
Imaging Service Request Comments	0040,2400	LT		X					
Referring Physician's Name	0008,0090	PN		X	X	X	X	Universal	
Requesting Physician	0032,1032	PN		X	X	X			
Requesting Service	0032,1033	LO		X					

4.2.1.3.3 (Real-World) Activity – Modality Performed Procedure Step as SCU

4.2.1.3.3.1 Description and Sequencing of Activities

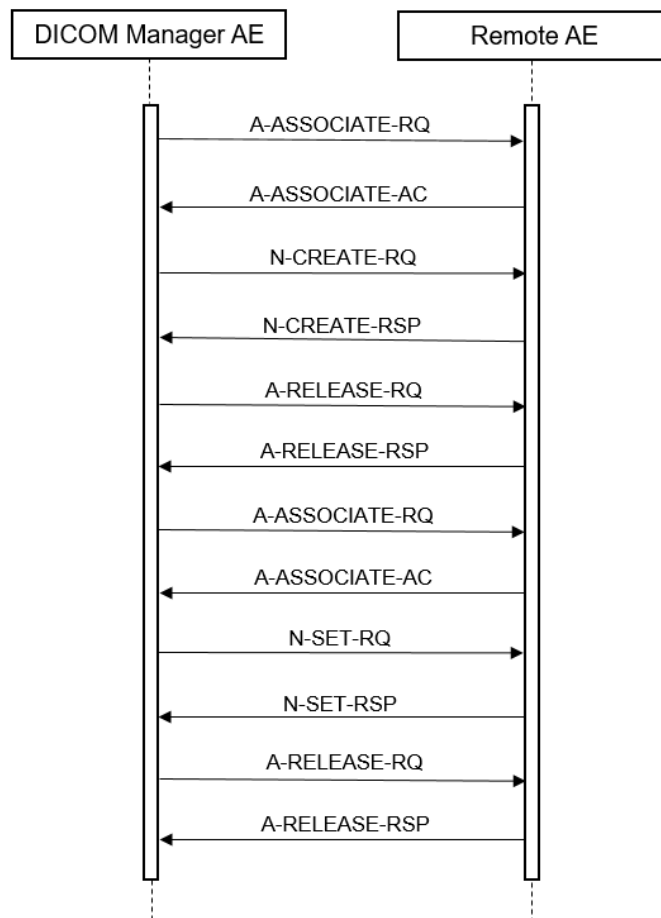

Figure 7: (Real World) Activity - Modality Performed Procedure Step as SCU

4.2.1.3.3.2 Proposed Presentation Contexts

The presentation contexts are defined in next table.

Table 19: Proposed Presentation Contexts for (Real-World) Activity – Modality Performed Procedure Step As SCU

Presentation Context Table					
Abstract Syntax		Transfer Syntax		Role	Extended Negotiation
Name	UID	Name List	UID List		
Modality Performed Procedure Step SOP Class	1.2.840.10008	Explicit VR Little Endian	1.2.840.10008.1.2.1	SCU	None
	.3.1.2.3.3	Implicit VR Little Endian	1.2.840.10008.1.2		

4.2.1.3.3.3 SOP Specific Conformance for Modality Performed Procedure Step SOP Class

This section and sub-section include the manufacturer SOP and Dataset specific information as well the status codes and their corresponding behavior.

4.2.1.3.3.3.1 Dataset Specific Conformance for Modality Performed Procedure Step SOP Class N-CREATE-SCU

Detail regarding the Dataset Specific response behavior will be reported in this section.

Table 20: MPPS Request Identifiers for N-CREATE-RQ

Attribute Name	Tag	VR	Value	Comment
SOP Common Module				
Specific Character Set	0008,0005	CS	ISO_IR 100	
Performed Procedure Step Relationship Module				
Referenced Patient Sequence	0008,1120	SQ		
>Referenced SOP Class UID	0008,1150	UI		
>Referenced SOP Instance UID	0008,1155	UI		
Patient's Name	0010,0010	PN		
Patient ID	0010,0020	LO		
Patient's Birth Date	0010,0030	DA		
Patient's Sex	0010,0040	CS		
Scheduled Step Attributes Sequence	0040,0270	SQ		
>Accession Number	0008,0050	SH		
>Referenced Study Sequence	0008,1110	SQ		
>>Referenced SOP Class UID	0008,1150	UI		
>>Referenced SOP Instance UID	0008,1155	UI		
>Study Instance UID	0020,000D	UI		
>Requested Procedure description	0032,1060	LO		
>Scheduled Procedure Step description	0040,0007	LO		
>Scheduled Protocol Code Sequence	0040,0008	SQ		
>>Code Value	0008,0100	SH		
>>Coding Scheme Designator	0008,0102	SH		
>>Coding Scheme Version	0008,0103	SH		
>Scheduled Procedure Step ID	0040,0009	SH		
>Requested Procedure ID	0040,1001	SH		
Performed Procedure Step Information Module				
Procedure Code Sequence	0008,1032	SQ		

Attribute Name	Tag	VR	Value	Comment
>Code Value	0008,0100	SH		
>Coding Scheme Designator	0008,0102	SH		
>Coding Meaning	0008,0104	LO		
Performed Station AE Title	0040,0241	AE		
Performed Station Name	0040,0242	SH		
Performed Location	0040,0243	SH		
Performed Procedure Step Start Date	0040,0244	DA		
Performed Procedure Step Start Time	0040,0245	TM		
Performed Procedure Step End Date	0040,0250	DA		
Performed Procedure Step End Time	0040,0251	TM		
Performed Procedure Step Status	0040,0252	CS	IN PROGRESS	
Performed Procedure Step ID	0040,0253	SH		
Performed Procedure Step Description	0040,0254	LO		
Performed Procedure Type Description	0040,0255	LO		
Image Acquisition Results Module				
Modality	0008,0060	CS	CT	
Study ID	0020,0010	SH		
Performed Protocol Code Sequence	0040,0260	SQ		
>Code Meaning	0008,0104	LO		
>Code Value	0008,0100	SH		
>Coding Scheme Designator	0008,0102	SH		
>Coding Scheme Meaning	0008,0104	LO		
Performed Series Sequence	0040,0340	SQ		
Radiation Dose Module				
Total Number of Exposures	0040,0301	US		
Exposure Dose Sequence	0040,030E	SQ		
Comments on Radiation Dose	0040,0310	ST		
Extended Dicom and Private attributes				
Specific Character Set	0008,0005	CS		
Implementor ID	00E1,0010	LO	ELSCINT1	
Elscent1_DLP total	00E1,1021	DS		

This part of the section includes the dataset specific behavior, i.e. error codes, error and exception handling, time-outs, etc.

Table 21: Status Response

Service Status	Error Code	Further Meaning	Behavior
Success	0000	Successful operation	The SCU successfully sends the modality performed procedure step create request. Log entry.
Other than Success	0106	Invalid attribute value	Association with problem will be logged. Association will be released.
	0116	Attribute Value Out Of Range	
	0105	No such Attribute	
	0107	Attribute List error	

Service Status	Error Code	Further Meaning	Behavior
	0110	MPPS may no longer be updated	

4.2.1.3.3.3.2 Dataset Specific Conformance for Modality Performed Procedure Step SOP Class N-SET-SCU

Detail regarding the Dataset Specific response behavior will be reported in this section.

Table 22: MPPS Request Identifiers for N-SET-RQ

Attribute Name	Tag	VR	Value	Comment
Performed Procedure Step Information Module				
Procedure Code Sequence	0008,1032	SQ		
>Code Value	0008,0100	SH		
>Coding Scheme Designator	0008,0102	SH		
>Code Meaning	0008,0104	LO		
Performed Procedure Step End Date	0040,0250	DA		
Performed Procedure Step End Time	0040,0251	TM		
Performed Procedure Step Status	0040,0252	CS		COMPLETED or DISCONTINUED
Performed Procedure Step Description	0040,0254	LO		
Performed Procedure Type Description	0040,0255	LO		
Image Acquisition Results Module				
Procedure Code Sequence	0040,0260	SQ		
>Code Value	0008,0100	SH		
>Coding Scheme Designator	0008,0102	SH		
>Code Meaning	0008,0104	LO		
Performed Series Sequence	0040,0340	SQ		
>Retrieve AE Title	0008,0054	AE		
>Series Description	0008,103E	LO		
>Performing Physician's Name	0008,1050	PN		
>Operators' Name	0008,1070	PN		Value entered in the new study window for operator name or in case no value entered, the operator name that is logged in the application is used.
>Referenced Image Sequence	0008,1140	SQ		
>>Referenced SOP Class UID	0008,1150	UI		
>>Referenced SOP Instance UID	0008,1155	UI		
>Protocol Name	0018,1030	LO		
>Series Instance UID	0020,000E	UI		
>Referenced Non-Image Composite SOP Instance Sequence	0040,0220	SQ		
Radiation Dose Module				
Total Number of Exposures	0040,0301	US		
Exposure Dose Sequence	0040,030E	SQ		
>KVP	0018,0060	DS		

Attribute Name	Tag	VR	Value	Comment
>Exposure Time	0018,1150	IS		
>X-ray Tube Current	0018,1151	IS		
>Radiation Mode	0018,115A	CS		
>CTDIvol	0018,9345	FD		
>Comments on Radiation Dose	0040,0310	ST		
Extended DICOM and Private attributes				
Implementor ID	00E1,0010	LO	ELSCINT1	
Elsclnt1_DLP total	00E1,1021	DS		

This part of the section includes the dataset specific behavior, i.e. error codes, error and exception handling, time-outs, etc.

Table 23: Status Response

Service Status	Error Code	Further Meaning	Behavior
Success	0000	Message received successfully by SCP	Association will be released
Other than Success	XXXX	Problems with receiving the N-SET Request by SCP	Problem will be logged. Association will be released.

4.2.1.3.4 (Real-World) Activity – FIND as SCU

4.2.1.3.4.1 Description and Sequencing of Activities

DICOM-Manager initiates an association when the user clicks on one of the icons in the devices tool-bar. The DICOM-Manager searches (C-FIND) by Study Level following by Series level and, optionally (configurable), by Image Level.

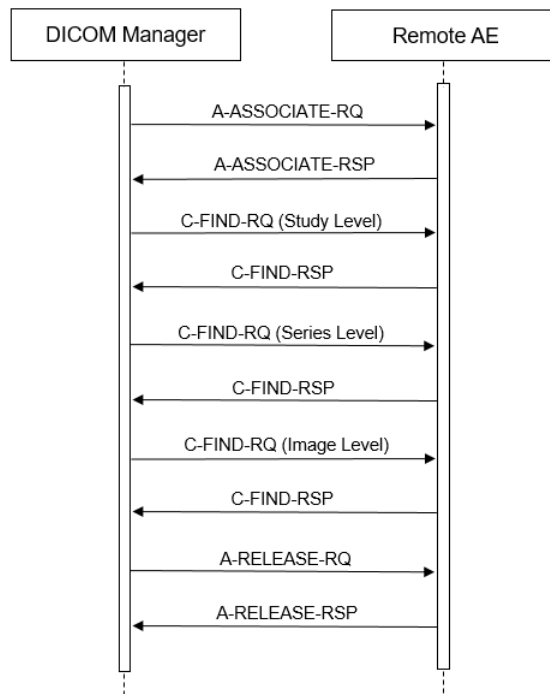

Figure 8: (Real World) Activity - FIND as SCU

4.2.1.3.4.2 Proposed Presentation Contexts

Each time an association is initiated, the association initiator proposes a number of presentation contexts to be used on that association. In this subsection, the presentation contexts proposed by Archive-Manager for (Real-World) Activity - Find as SCU are defined in the Table below.

Table 24: Proposed Presentation Contexts for (Real-World) Activity – FIND as SCU

Presentation Context Table					
Abstract Syntax		Transfer Syntax		Role	Extended Negotiation
Name	UID	Name List	UID List		
Study Root QR Information Model - FIND SOP Class	1.2.840.10008.5.1.4.1.2.2.1	Explicit VR Little Endian	1.2.840.10008.1.2.1	SCU	None
		Implicit VR Little Endian	1.2.840.10008.1.2		

4.2.1.3.4.3 SOP Specific Conformance for Study Root QR Information Model – FIND SOP Class

This section and sub-section includes the manufacturer SOP and Dataset specific information as well the status codes and their corresponding behavior.

4.2.1.3.4.3.1 Dataset Specific Conformance for Study Root QR Information Model – FIND SOP Class C-FIND-SCU

Detail regarding the Dataset Specific response behavior will be reported in this section.

Table 25: Supported Query Keys for Study Root Information Model

Study Root Information Model				
Attribute Name	Tag	VR	Type of Matching	Comment
Query/Retrieve Level	0008,0052	CS	Single Value	STUDY, SERIES, IMAGES
Specific Character Set	0008,0005	CS		
Q/R Study level				
Study Date	0008,0020	DA	Range, Universal	
Study Time	0008,0030	TM	Universal	
Accession Number	0008,0050	SH	Universal	
Modalities in Study	0008,0061	CS	Single Value, Universal, List Of Values	
Referring Physician's Name	0008,0090	PN	Universal, Wildcard	
Study Description	0008,1030	LO	Wildcard, Universal	
Patient's Name	0010,0010	PN	Universal, Wildcard	
Patient ID	0010,0020	LO	Single Value, Universal, Wildcard	
Patient's Birth Date	0010,0030	DA	Universal	
Patient's Birth Time	0010,0032	TM	Universal	
Patient's Sex	0010,0040	CS	Single Value, Universal	
Study Instance UID	0020,000D	UI	Universal	
Study ID	0020,0010	SH	Single Value, Universal, Wildcard	
Number of Study Related Series	0020,1206	IS	Universal	
Number of Study Related Instances	0020,1208	IS	Universal	

Study Root Information Model				
Attribute Name	Tag	VR	Type of Matching	Comment
Q/R Series Level				
Series Date	0008,0021	DA	Universal	
Series Time	0008,0031	TM	Universal	
Modality	0008,0060	CS	Universal	
Manufacturer	0008,0070	LO	Universal	
Series Description	0008,103E	LO	Universal	
Body Part Examined	0018,0015	CS	Universal	
Protocol Name	0018,1030	LO	Universal	
Study Instance UID	0020,000D	UI	Single Value	
Series Instance UID	0020,000E	UI	Universal	
Series Number	0020,0011	IS	Universal	
Number of Series Related Instances	0020,1209	IS	Universal	
Performed Procedure Step Start Date	0040,0244	DA	Universal	
Performed Procedure Step Start Time	0040,0245	TM	Universal	
Request Attributes Sequence	0040,0275	SQ	Universal	
>Scheduled Procedure Step ID	0040,0009	SH	Universal	
>Requested Procedure ID	0040,1001	SH	Universal	
Q/R Image Level				
Image Type	0008,0008	CS	Universal	
Instance Creation Date	0008,0012	DA	Universal	
Instance Creation Time	0008,0013	TM	Universal	
SOP Class UID	0008,0016	UI	Universal	
SOP Instance UID	0008,0018	UI	Universal	
Contrast/Bolus Agent	0018,0010	LO	Universal	
Slice Thickness	0018,0050	DS	Universal	
KVP	0018,0060	DS	Universal	
Study Instance UID	0020,000D	UI	Single Value	
Series Instance UID	0020,000E	UI	Single Value	
Instance Number	0020,0013	IS	Universal	
Patient Orientation	0020,0020	CS	Universal	
Image Orientation (Patient)	0020,0037	DS	Universal	
Frame of Reference UID	0020,0052	UI	Universal	
Slice Location	0020,1041	DS	Universal	
Samples per Pixel	0028,0002	US	Universal	
Photometric Interpretation	0028,0004	CS	Universal	
Rows	0028,0010	US	Universal	
Columns	0028,0011	US	Universal	
Pixel Spacing	0028,0030	DS	Universal	

This part of the section includes the dataset specific behavior, i.e. error codes, error and exception handling, time-outs, etc.

Table 26: Status Response

Service Status	Error Code	Further Meaning	Behavior
Success	0000	Success	Matching is successful. Query results are displayed in UI
Cancel	FE00	Matching terminated due to Cancel request	Error code is logged, no query results are displayed in UI
Failure	A700	Refused - Out of resources	Error code is logged, no query results are displayed in UI
	A900	Failed - Identifier does not match SOP Class	Error code is logged, no query results are displayed in UI
	C000	Failed - Unable to process	Error code is logged, no query results are displayed in UI
	C100	Failed - More than one match found	Error code is logged, no query results are displayed in UI
	C200	Failed – Unable to support requested template	Error code is logged, no query results are displayed in UI

4.2.1.3.5 (Real-World) Activity – MOVE as SCU

4.2.1.3.5.1 Description and Sequencing of Activities

The RWA Move Remote Images involves the retrieve of images on a remote system by moving (copying) the matching images from the remote database to another database.

The operator is able to copy the selected images in a patient folder from a remote database to another, local or remote, database by means of the copy tool in the DICOM Manager data handling facility. The DICOM Manager initiates for each copy request an association to the selected peer entity (Remote AE) and uses it to send the Retrieve (C-MOVE) request (and receive the associated responses). The association is released after the final Retrieve (C-MOVE) response for the related request has been received with the status success / failure.

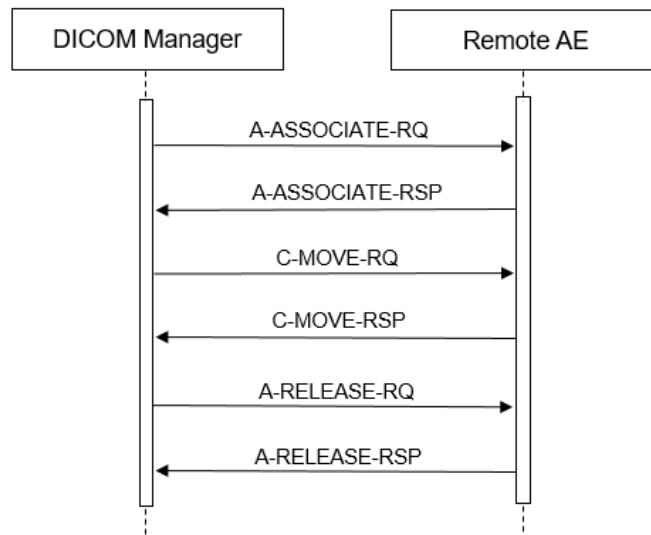

Figure 9: (Real World) Activity - MOVE as SCU

4.2.1.3.5.2 Proposed Presentation Contexts

Each time an association is initiated, the association initiator proposes a number of presentation contexts to be used on that association.

In this subsection, the presentation contexts proposed by DICOM-Manager for (Real-World) Activity - Move as SCU are defined in the following table.

Table 27: Proposed Presentation Contexts for (Real-World) Activity – MOVE as SCU

Presentation Context Table					
Abstract Syntax		Transfer Syntax		Role	Extended Negotiation
Name	UID	Name List	UID List		
Study Root QR Information Model - MOVE SOP Class	1.2.840.10008.5.1.	Explicit VR Little Endian	1.2.840.10008.1.2.1	SCU	None
	4.1.2.2.2	Implicit VR Little Endian	1.2.840.10008.1.2		

4.2.1.3.5.3 SOP Specific Conformance for Study Root QR Information Model – MOVE SOP Class

This section and sub-section includes the manufacturer SOP and Dataset specific information as well the status codes and their corresponding behavior.

DICOM-Manager provides standard conformance to the DICOM V3.0 Query/Retrieve Service Class as an SCU for the SOP Class Study Root Query/Retrieve Information Model – Move.

4.2.1.3.5.3.1 Dataset Specific Conformance for Study Root QR Information Model – MOVE SOP Class C-MOVE-SCU

Detail regarding the Dataset Specific response behavior will be reported in this section.

Table 28: Identifiers for MOVE Study Root Information Model as SCU

Study Root Information Model			
Attribute Name	Tag	VR	Comment
Query/Retrieve Level	0008, 0052	CS	STUDY, SERIES, IMAGES
Q/R Study level			
Study Instance UID	0020, 000D	UI	
Q/R Series level			
Series Instance UID	0020,000E	UI	
Study Instance UID	0020,000D	UI	
Q/R Image level			
Series Instance UID	0020,000E	UI	
SOP Instance UID	0008,0018	UI	
Study Instance UID	0020,000D	UI	

This part of the section includes the dataset specific behavior, i.e. error codes, error and exception handling, time-outs, etc.

Table 29: Status Response

Service Status	Error Code	Further Meaning	Behavior
Success	0000	Success	Storage is successful.

Service Status	Error Code	Further Meaning	Behavior
Cancel	FE00	Sub-operations terminated due to Cancel indication	On receiving status 0xFE00 (Sub-operations terminated due to Cancel indication), the SUT will not display any retrieve results. The reason is logged. Retrieve job is failed in the job viewer.
Failure	A701	Refused - Out of Resources – Unable to calculate number of matches	On receiving status 0xA701 (Refused – Out of Resources – Unable to calculate number of matches), the SUT will not display any retrieve results. The reason is logged. Retrieve job is failed in the job viewer.
	A702	Refused - Out of Resources	On receiving status 0xA702 (Refused: Out of Resources – Unable to perform sub-operations), the SUT will not display any retrieve results. The reason is logged. Retrieve job is failed in the job viewer.
	A801	Refused - Move Destination Unknown	On receiving status 0xA801 (Refused: Move destination unknown) the SUT will not display any retrieve results. The reason is logged. Retrieve job is failed in the job viewer.
	A900	Error - Identifier Does Not Match SOP Class	On receiving status 0xA900 (Identifier does not match SOP Class), the SUT will not display any retrieve results. The reason is logged. Retrieve job is failed in the job viewer.
	Cxxx	Error - Unable to Process	On receiving status 0xCxxx (Unable to process), the SUT will not display any retrieve results. The reason is logged. Retrieve job is failed in the job viewer.
Warning	B000	Sub-operations complete - One or more failures	On receiving status 0xB000 (Sub-operations complete - One or more failures), the SUT will not display any retrieve results. The reason is logged. Retrieve job is failed in the job viewer.

4.2.1.3.6 (Real-World) Activity – Image Export

4.2.1.3.6.1 Description and Sequencing of Activities

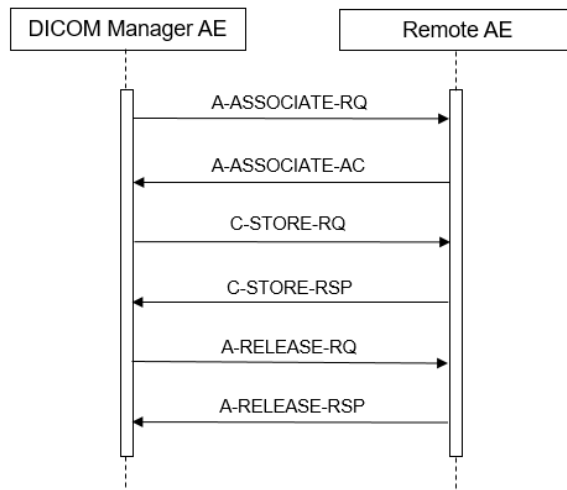

Figure 10: (Real World) Activity – Image Export

The associated Real-World Activity is a request for retrieval of images from the disk or save operation from iCT, iCT-SP CT applications and storage of the images to a remote system using a C-STORE command.

4.2.1.3.6.2 Proposed Presentation Contexts

Each time an association is initiated, the association initiator proposes a number of presentation contexts to be used on that association.

The system configuration (by FSE in LanConfig) allows disabling individually each of the supported syntaxes per remote device when establishing and accepting associations. At least one of the syntaxes will be enabled.

When establishing an association to a remote device, all the enabled (for that device) syntaxes will be proposed based on the SOP Class. If more than one Transfer Syntax is accepted by the SCP, the order of selecting the syntax to use is: P-ELE, JPEG, ELE and ILE. However if the proposed SOP class does not contain any pixel data then only ELE and ILE will be proposed.

When a device is newly added in LanConfig, by default the selected transfer syntaxes for the device are ELE & ILE. If the device is a Philips device which is more recent than iCT, iCT-SP CT then P-ELE will also be selected by default. The user will have the option of changing the selected transfer syntax per device using LanConfig.

iCT, iCT-SP CT supports Level2 DICOM transparency and hence will preserve all the source image data.

The presentation contexts proposed by the DICOM Manager for (Real-World) Activity (C-STORE SCU) are defined in the following table.

Table 30: Proposed Presentation Contexts for (Real-World) Activity – Image Export

Presentation Context Table					
Abstract Syntax		Transfer Syntax		Role	Extended Negotiation
Name	UID	Name List	UID List		
Computed Radiography Image Storage SOP Class	1.2.840.10008.5.1.4.1.1.1	JPEG Lossless, Non-Hierarchical, FOP (Process 14)	1.2.840.10008.1.2.4.70	SCU	None
		CT-private-ELE	1.3.46.670589.33.1.4.1		
		Explicit VR Little Endian	1.2.840.10008.1.2.1		
		Implicit VR Little Endian	1.2.840.10008.1.2		
Digital X-Ray Image Storage - For Pres. SOP Class	1.2.840.10008.5.1.4.1.1.11.2.840.10008.5.1.4.1.1.1.1	Explicit VR Little Endian	1.2.840.10008.1.2.1	SCU	None
		Implicit VR Little Endian	1.2.840.10008.1.2		
		CT-private-ELE	1.3.46.670589.33.1.4.1		
		JPEG Lossless, Non-Hierarchical, FOP (Process 14)	1.2.840.10008.1.2.4.70		
Digital X-Ray Image Storage - For Proc. SOP Class	1.2.840.10008.5.1.4.1.1.1.1.1	Explicit VR Little Endian	1.2.840.10008.1.2.1	SCU	None
		Implicit VR Little Endian	1.2.840.10008.1.2		
		CT-private-ELE	1.3.46.670589.33.1.4.1		
		JPEG Lossless, Non-Hierarchical, FOP (Process 14)	1.2.840.10008.1.2.4.70		
	1.2.840.10008.5.1.4.1.1.12.1	Explicit VR Little Endian	1.2.840.10008.1.2.1	SCU	None
		Implicit VR Little Endian	1.2.840.10008.1.2		

Presentation Context Table					
Abstract Syntax		Transfer Syntax		Role	Extended Negotiation
Name	UID	Name List	UID List		
X-Ray Angiographic Image Storage SOP Class		CT-private-ELE	1.3.46.670589.33.1.4.1		
		JPEG Lossless, Non-Hierarchical, FOP (Process 14)	1.2.840.10008.1.2.4.70		
X-Ray Radiofluoroscopic Image Storage SOP Class	1.2.840.10008.5.1.4.1.1.12.2	Explicit VR Little Endian	1.2.840.10008.1.2.1	SCU	None
		Implicit VR Little Endian	1.2.840.10008.1.2		
		CT-private-ELE	1.3.46.670589.33.1.4.1		
		JPEG Lossless, Non-Hierarchical, FOP (Process 14)	1.2.840.10008.1.2.4.70		
CT Image Storage SOP Class	1.2.840.10008.5.1.4.1.1.2	Explicit VR Little Endian	1.2.840.10008.1.2.1	SCU	None
		Implicit VR Little Endian	1.2.840.10008.1.2		
		CT-private-ELE	1.3.46.670589.33.1.4.1		
		JPEG Lossless, Non-Hierarchical, FOP (Process 14)	1.2.840.10008.1.2.4.70		
Secondary Capture Image Storage SOP Class	1.2.840.10008.5.1.4.1.1.7	Explicit VR Little Endian	1.2.840.10008.1.2.1	SCU	None
		Implicit VR Little Endian	1.2.840.10008.1.2		
		CT-private-ELE	1.3.46.670589.33.1.4.1		
		JPEG Lossless, Non-Hierarchical, FOP (Process 14)	1.2.840.10008.1.2.4.70		
X-Ray Radiation Dose SR SOP Class	1.2.840.10008.5.1.4.1.1.88.67	Explicit VR Little Endian	1.2.840.10008.1.2.1	SCU	None
		Implicit VR Little Endian	1.2.840.10008.1.2		
General ECG Waveform Storage SOP Class	1.2.840.10008.5.1.4.1.1.9.1.2	Explicit VR Little Endian	1.2.840.10008.1.2.1	SCU	None
		Implicit VR Little Endian	1.2.840.10008.1.2		
MR Image Storage SOP Class	1.2.840.10008.5.1.4.1.1.4	Explicit VR Little Endian	1.2.840.10008.1.2.1	SCU	None
		Implicit VR Little Endian	1.2.840.10008.1.2		
		JPEG Lossless, Non-Hierarchical, FOP (Process 14)	1.2.840.10008.1.2.4.70		
Nuclear Medicine Image Storage SOP Class	1.2.840.10008.5.1.4.1.1.20	Explicit VR Little Endian	1.2.840.10008.1.2.1	SCU	None
		Implicit VR Little Endian	1.2.840.10008.1.2		
Digital Intraoral X-Ray Image Storage For Presentation SOP Class	1.2.840.10008.5.1.4.1.1.1.3	Explicit VR Little Endian	1.2.840.10008.1.2.1	SCU	None
		Implicit VR Little Endian	1.2.840.10008.1.2		
		JPEG Lossless, Non-Hierarchical, FOP (Process 14)	1.2.840.10008.1.2.4.70		
		Explicit VR Little Endian	1.2.840.10008.1.2.1		

Presentation Context Table					
Abstract Syntax		Transfer Syntax		Role	Extended Negotiation
Name	UID	Name List	UID List		
Digital Intraoral X-Ray Image Storage For Processing SOP Class	1.2.840.10008.5.1.4.1.1.1.3.1	Implicit VR Little Endian	1.2.840.10008.1.2		
		JPEG Lossless, Non-Hierarchical, FOP (Process 14)	1.2.840.10008.1.2.4.70		
Grayscale Presentation SOP Class	1.2.840.10008.5.1.4.1.1.11.1	Explicit VR Little Endian	1.2.840.10008.1.2.1	SCU	None
		Implicit VR Little Endian	1.2.840.10008.1.2		
Color Softcopy Presentation State Storage SOP Class	1.2.840.10008.5.1.4.1.1.11.2	Explicit VR Little Endian	1.2.840.10008.1.2.1	SCU	None
		Implicit VR Little Endian	1.2.840.10008.1.2		
Pseudo-Color Softcopy Presentation State Storage SOP Class	1.2.840.10008.5.1.4.1.1.11.3	Explicit VR Little Endian	1.2.840.10008.1.2.1	SCU	None
		Implicit VR Little Endian	1.2.840.10008.1.2		
Blending Softcopy Presentation State Storage SOP Class	1.2.840.10008.5.1.4.1.1.11.4	Explicit VR Little Endian	1.2.840.10008.1.2.1	SCU	None
		Implicit VR Little Endian	1.2.840.10008.1.2		
Real World Value Mapping Storage SOP Class	1.2.840.10008.5.1.4.1.1.67	Explicit VR Little Endian	1.2.840.10008.1.2.1	SCU	None
		Implicit VR Little Endian	1.2.840.10008.1.2		
Raw Data Storage SOP Class	1.2.840.10008.5.1.4.1.1.66	Explicit VR Little Endian	1.2.840.10008.1.2.1	SCU	None
		Implicit VR Little Endian	1.2.840.10008.1.2		
Key Object Selection Document Storage SOP Class	1.2.840.10008.5.1.4.1.1.88.59	Explicit VR Little Endian	1.2.840.10008.1.2.1	SCU	None
		Implicit VR Little Endian	1.2.840.10008.1.2		
Positron Emission Tomography Image Storage SOP Class	1.2.840.10008.5.1.4.1.1.128	Explicit VR Little Endian	1.2.840.10008.1.2.1	SCU	None
		Implicit VR Little Endian	1.2.840.10008.1.2		
		JPEG Lossless, Non-Hierarchical, FOP (Process 14)	1.2.840.10008.1.2.4.70		
Digital Mammography X-Ray Image Storage For Presentation SOP Class	1.2.840.10008.5.1.4.1.1.1.2	Explicit VR Little Endian	1.2.840.10008.1.2.1	SCU	None
		Implicit VR Little Endian	1.2.840.10008.1.2		
		JPEG Lossless, Non-Hierarchical, FOP (Process 14)	1.2.840.10008.1.2.4.70		
Digital Mammography X-Ray Image Storage For Processing	1.2.840.10008.5.1.4.1.1.1.2.1	Explicit VR Little Endian	1.2.840.10008.1.2.1	SCU	None
		Implicit VR Little Endian	1.2.840.10008.1.2		
		JPEG Lossless, Non-Hierarchical, FOP (Process 14)	1.2.840.10008.1.2.4.70		
RT Image Storage SOP Class	1.2.840.10008.5.1.4.1.1.481.1	Explicit VR Little Endian	1.2.840.10008.1.2.1	SCU	None
		Implicit VR Little Endian	1.2.840.10008.1.2		
		JPEG Lossless, Non-Hierarchical, FOP (Process 14)	1.2.840.10008.1.2.4.70		
		Explicit VR Little Endian	1.2.840.10008.1.2.1	SCU	None

Presentation Context Table					
Abstract Syntax		Transfer Syntax		Role	Extended Negotiation
Name	UID	Name List	UID List		
RT Dose Storage SOP Class	1.2.840.10008.5.1.4.1.1.481.2	Implicit VR Little Endian	1.2.840.10008.1.2		
		JPEG Lossless, Non-Hierarchical, FOP (Process 14)	1.2.840.10008.1.2.4.70		
RT Structure Set Storage SOP Class	1.2.840.10008.5.1.4.1.1.481.3	Explicit VR Little Endian	1.2.840.10008.1.2.1	SCU	None
		Implicit VR Little Endian	1.2.840.10008.1.2		
RT Plan Storage SOP Class	1.2.840.10008.5.1.4.1.1.481.5	Explicit VR Little Endian	1.2.840.10008.1.2.1	SCU	None
		Implicit VR Little Endian	1.2.840.10008.1.2		
Encapsulated PDF Storage SOP Class	1.2.840.10008.5.1.4.1.1.104.1	Explicit VR Little Endian	1.2.840.10008.1.2.1	SCU	None
		Implicit VR Little Endian	1.2.840.10008.1.2		
Spatial Registration Storage SOP Class	1.2.840.10008.5.1.4.1.1.66.1	Explicit VR Little Endian	1.2.840.10008.1.2.1	SCU	None
		Implicit VR Little Endian	1.2.840.10008.1.2		
		JPEG Lossless, Non-Hierarchical, FOP (Process 14)	1.2.840.10008.1.2.4.70		
Multiframe Single Bit Secondary Capture Image Storage	1.2.840.10008.5.1.4.1.1.7.1	Explicit VR Little Endian	1.2.840.10008.1.2.1	SCU	None
		Implicit VR Little Endian	1.2.840.10008.1.2		
Multiframe Grayscale Byte Secondary Capture Image Storage SOP Class	1.2.840.10008.5.1.4.1.1.7.2	Explicit VR Little Endian	1.2.840.10008.1.2.1	SCU	None
		Implicit VR Little Endian	1.2.840.10008.1.2		
Multiframe Grayscale Word Secondary Capture Image Storage	1.2.840.10008.5.1.4.1.1.7.3	Explicit VR Little Endian	1.2.840.10008.1.2.1	SCU	None
		Implicit VR Little Endian	1.2.840.10008.1.2		
Multiframe True Color Secondary Capture Image Storage	1.2.840.10008.5.1.4.1.1.7.4	Explicit VR Little Endian	1.2.840.10008.1.2.1	SCU	None
	1.2.840.10008.5.1.4.1.1.3.1	Implicit VR Little Endian	1.2.840.10008.1.2		

"JPEG" here refers to JPEG Lossless, Non-Hierarchical, First-Order Prediction (Process 14 [Selection Value 1]): Default Transfer Syntax for Lossless JPEG Image Compression.

It will apply the following priorities to the choice of Transfer Syntax which can be configured in LAN Config Tool.

Table 31: Transfer Syntax Priorities

Transfer Syntax	UID	Comment
1. CT-private-ELE	1.3.46.670589.33.1.4.1	LanConfig. Refers to RLE compression transfer syntax.
2. DICOM JPEG Lossless, Non-Hierarchical, FOP (Process 14)	1.2.840.10008.1.2.4.70	LanConfig, Transfer Syntax for Lossless JPEG Image Compression (JPEG).
3. DICOM Explicit VR Little Endian	1.2.840.10008.1.2.1	LanConfig.
4. DICOM Implicit VR Little Endian	1.2.840.10008.1.2	LanConfig, default.

Note: No support of JPEG & P-ELE transfer syntaxes for all SOP classes without pixel data.

4.2.1.3.6.3 SOP Specific Conformance for Storage SOP Class

DICOM Manager AE provides standard conformance to the DICOM V3.0 Storage Service Class as an SCU for SOP Classes mentioned in the previous section.

Any unsuccessful status (error or warning), returned in the C-STORE Response, results in termination of sending further C-STORE requests (if any in the queue) and reporting of the error to the system log file and UI (Queue Manager)

There are two timeouts for the association. One timeout, "Association Timeout" is used to close an idle association. For C-STORE the default is 120 sec and can be configured per remote DICOM node. The other timeout is "Service Timeout" which detects that no data is transmitted over the association and closes it. The default "Service Timeout" for C-STORE is 5 minutes.

4.2.1.3.6.3.1 Dataset Specific Conformance for Study Root QR Information Model – FIND SOP Class C-FIND-SCU

Detail regarding the Dataset Specific response behavior will be reported in this section.

This includes the dataset specific behavior, i.e. error codes, error and exception handling, time-outs, etc

Table 32: Status Response

Service Status	Error Code	Further Meaning	Behavior
Success	0000	Success	Export is successful.
Failure	0212	Error - Mistyped Argument	Export will fail in queue manager and the failure reason is logged.
	A701	Error - Out of Resources	Export will fail in queue manager and the failure reason is logged.
	0210	Error – Duplicate Invocation	Export will fail in queue manager and the failure reason is logged.
	0117	Error - Invalid Object Instance	Export will fail in queue manager and the failure reason is logged.
	A900	Error - Data Set does not match SOP	Export will fail in queue manager and the failure reason is logged.
	C000	Error - Cannot understand	Export will fail in queue manager and the failure reason is logged.
	A901	Error - Data Set Does Not Match	Export will fail in queue manager and the failure reason is logged.
Warning	B000	Coercion of Data Elements	Export is success with a warning reason logged.
	B006	Elements Discarded	Export is success with a warning reason logged.
	B007	Data Set does not match	Export is success with a warning reason logged.
	0107	Attribute List Error	Export is success with a warning reason logged.

4.2.1.3.7 (Real-World) Activity – Storage Commitment Push Model AS SCU

4.2.1.3.7.1 Description and Sequencing of Activities

DICOM-Manager will attempt to initiate a new association when requested to commit the images that were stored on a remote device, which supports the storage Commitment Service.

The associated real world activity for the N-ACTION is a storage commitment request to the remote storage device.

The associated real world activity for the N-EVENT-REPORT operation is the completion of the storage commitment by the remote device.

This can be as Synchronous storage commitment as the N-EVENT-REPORT-RQ is received inside the configure timeout or as Asynchronous storage commitment after the Release-RQ by the timeout is already sent to the remote system.

DICOM-Manager will issue a failure status if it is unable to properly handle the storage commitment report event.

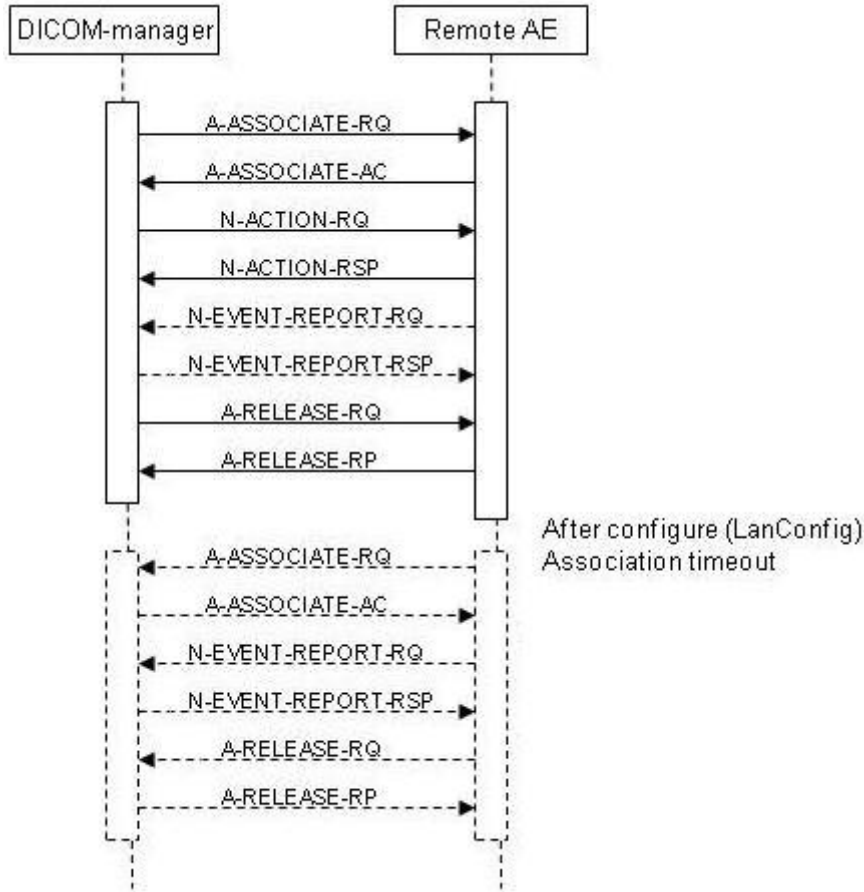

Figure 11: (Real World) Activity- DICOM Manager (Storage Commitment)

4.2.1.3.7.2 Proposed Presentation Contexts

Each time an association is initiated, the association initiator proposes a number of presentation contexts to be used on that association.

The presentation contexts proposed by DICOM Manager for (Real-World) Activity - Storage Commitment as SCU are defined in the following table.

Table 33: Proposed Presentation Contexts for (Real-World) Activity – Storage Commitment Push Model AS SCU

Presentation Context Table					
Abstract Syntax		Transfer Syntax		Role	Extended Negotiation
Name	UID	Name List	UID List		
Storage Commitment Push Model SOP Class	1.2.840.10008.1.	Explicit VR Little Endian	1.2.840.10008.1.2.1	SCU	None
	20.1	Implicit VR Little Endian	1.2.840.10008.1.2		

4.2.1.3.7.3 SOP Specific Conformance for Storage Commitment Push Model SOP Class

DICOM-Manager provides standard conformance to the DICOM V3.0 Storage Commitment Service Class using Push Model as an SCU.

Multiple N-ACTION-RQ can be performed over a single association. Multiple N-EVENT-REPORT-RQ can be accepted over a single association. After all N-ACTION-RQ that are waiting in the stack are issued, association will be closed with the timeout which is configurable using LanConfig.

A remote system reports about storage commitment completion using an N-EVENT-REPORT-RQ command. The system accepts the N-EVENT-REPORT-RQ commands over a separate association initiated by the remote system, using reverse role negotiation for the asynchronous behaviour after the earlier connection was timedout.

Storage Commitment for individual images are grouped into large "chunks" and issued as a single Storage Commitment request.

Table 34: DICOM Command Communication Failure Behavior Storage Commitment

Exception	Behavior
ARTIM Time-out	The reason is logged
Reply Time-out	The association is released. Continues with waiting for storage commitment
Association Time-out SCU	The association is released. Continues with waiting for storage commitment
Association aborted	Continues with waiting for storage commitment

4.2.1.3.7.3.1 Dataset Specific Conformance for Storage Commitment Push Model SOP Class N-ACTION-SCU

All details regarding the specific conformance, including response behavior to all status codes, both from an application level and communication errors are provided in following tables for N-ACTION.

Table 35: Status Response

Service Status	Error Code	Further Meaning	Behavior
Success	0000	Success	The request for storage commitment is considered successfully stored.
Other than Success	<xxxx>	Problems with sending the N-ACTION Request	The request for storage commitment is marked as failed.

4.2.1.3.7.3.2 Dataset Specific Conformance for Storage Commitment Push Model SOP Class N-EVENT-REPORT-SCP

All details regarding the specific conformance, including response behavior to all status codes, both from an application level and communication errors are provided in following tables for N-EVENT-REPORT.

Table 36: Storage Commitment N-EVENT-REPORT Behavior

Event Type Name	Event Type	Behavior
Storage Commitment Request Successful	1	Awaiting Storage Commitment request will be moved to complete in Queue Manager.
Storage Commitment Request Complete - Failures Exist	2	Awaiting Storage Commitment request will be moved to fail in Queue Manager.

Table 37: Storage Commitment N-EVENT-REPORT Failure Handling Behavior

Service Status	Error Code	Further Meaning	Description
Success	0000	Success	The storage commitment result has been successfully received.

4.2.1.4. Association Acceptance Policy

The Application Entity may reject Association attempts as shown in the table below.

Table 38: DICOM Association Reject Reasons

Result	Source	Reason/Diagnosis	Behavior
1 - rejected-permanent	1 - DICOM UL service-user	2 - application-context-name-not supported	Association is rejected and the reason is logged.
		3 - calling-AE-title-not-recognized	Association is rejected and the reason is logged.
		7 - called-AE-title-not-recognized	Association is rejected and the reason is logged.
	2 - DICOM UL service-provider (ACSE related function)	1 - no-reason-given	Association is rejected and the reason is logged.
		2 - protocol-version-not-supported	Association is rejected and the reason is logged.

The behavior of the AE on DICOM receiving Association Abort Handling is summarized in table below.

Table 39: DICOM receiving Association Abort Handling

Source	Reason/Diagnosis	Behavior
0 - DICOM UL service-user (initiated abort)	0 - reason-not-specified	Abort is logged and connection is closed.
2 - DICOM UL service-provider (initiated abort)	0 - reason-not-specified	Abort is logged and connection is closed.
	1 - unrecognized-PDU	Abort is logged and connection is closed.
	2 - unexpected-PDU	Abort is logged and connection is closed.
	4 - unrecognized-PDU parameter	Abort is logged and connection is closed.
	5 - unexpected-PDU parameter	Abort is logged and connection is closed.
	6 - invalid-PDU-parameter value	Abort is logged and connection is closed.

The behavior of the AE for sending an association abort is summarized in next table.

Table 40: Association Abort Policies

Source	Reason/Diagnosis	Behavior
0 - DICOM UL service-user (initiated abort)	0 - reason-not-specified	When an association timeout (configurable per remote device) expired (timeout which determines how long to keep an idle association).When receiving a PDU whose size is bigger than the agreed max PDU size.
2 - DICOM UL service-provider (initiated abort)	1 - unrecognized-PDU	Whenever the system receives unexpected or unrecognized PDU (according to the DICOM UPPER LAYER PROTOCOL STATE TRANSITION TABLE in chapter 8 of the DICOM standard).

4.2.1.4.1 (Real-World) Activity – Verification as SCP

4.2.1.4.1.1 Description and Sequencing of Activities

A remote system requests verification from DICOM Manager using the C-ECHO command.

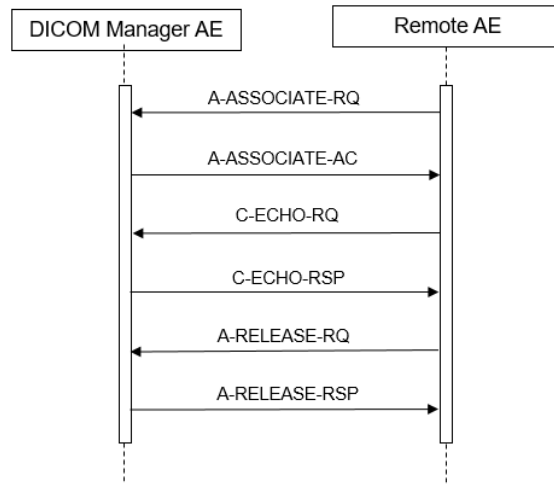

Figure 12: (Real World) Activity - Verification as SCP

4.2.1.4.1.2 Accepted Presentation Contexts

The presentation contexts are defined in next table.

Table 41: Accepted Presentation Contexts for (Real-World) Activity – Verification as SCP

Presentation Context Table					
Abstract Syntax		Transfer Syntax		Role	Extended Negotiation
Name	UID	Name List	UID List		
Verification SOP Class	1.2.840.10008.1.1	Explicit VR Little Endian	1.2.840.10008.1.2.1	SCP	None
		Implicit VR Little Endian	1.2.840.10008.1.2		

4.2.1.4.1.3 SOP Specific Conformance for Verification SOP Class

This section and sub-section includes the manufacturer SOP and Dataset specific information as well the status codes and their corresponding behavior.

DICOM Manager (C-ECHO SCP) provides standard conformance to the DICOM V3.0 verification SOP Class.

4.2.1.4.1.3.1 Dataset Specific Conformance for Verification C-ECHO SCP

Detail regarding the Dataset Specific response behavior will be reported in this section.

This part of the section includes the dataset specific behavior, i.e. error codes, error and exception handling, time-outs, etc.

Table 42: Status Response

Service Status	Error Code	Further Meaning	Behavior
Success	0000	Success	C-ECHO command was successful received.

4.2.1.4.2 (Real-World) Activity – FIND as SCP

4.2.1.4.2.1 Description and Sequencing of Activities

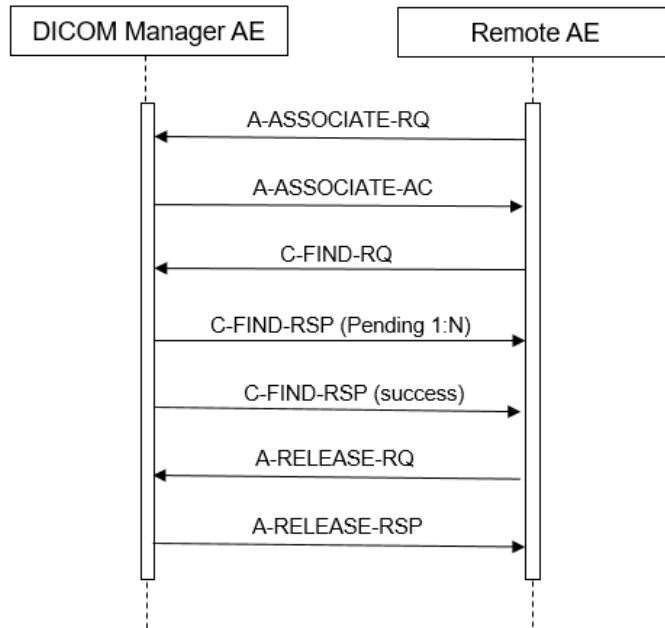

Figure 13: (Real World) Activity - FIND as SCP

The Real World activity associated with the C-FIND-SCP is querying of the local data base based on C-FIND-RQ from the remote DICOM node. DICOM Manager will issue a failure status if it is unable to process the query request.

4.2.1.4.2.2 Accepted Presentation Contexts

The presentation contexts are defined in next table.

Table 43: Acceptable Presentation Contexts for (Real-World) Activity – FIND as SCP

Presentation Context Table					
Abstract Syntax		Transfer Syntax		Role	Extended Negotiation
Name	UID	Name List	UID List		
Study Root QR Information Model - FIND SOP Class	1.2.840.10008.5.1.4.1.2.2.1	Explicit VR Little Endian	1.2.840.10008.1.2.1	SCP	None
		Implicit VR Little Endian	1.2.840.10008.1.2		

4.2.1.4.2.3 SOP Specific Conformance for Study Root QR Information Model – FIND SOP Class

This section and sub-section includes the manufacturer SOP and Dataset specific information as well the status codes and their corresponding behavior.

DICOM Manager provides standard conformance to the DICOM V3.0 Query/Retrieve Service Class as an SCP for the following SOP Class: Study Root Query/Retrieve Information Model - FIND, UID=1.2.840.10008.5.1.4.1.2.2.1.

4.2.1.4.2.3.1 Dataset Specific Conformance for Study Root QR Information Model – FIND SOP Class C-FIND-SCP

Detail regarding the Dataset Specific response behavior will be reported in this section.

iCT, iCT-SP CT does not support Relational Search, a query that may contain any combination of keys at any level in the hierarchy. Starting at the top level in the Query/Retrieve Information Model, continuing until the Query/Retrieve level specified in the C-FIND request is reached.

All Required (R) and Unique (U) Study, Series and Image level keys for the Study Root Query/Retrieve Information Model are supported.

Unsupported fields will not be returned in the C-FIND response

Table 44: Requested Query Keys for Study Root Information Model

Study Root Information Model				
Attribute Name	Tag	VR	Type of Matching	Comment
Query/Retrieve Level	0008,0052	CS	Universal	
Q/R Study level				
Study Date	0008,0020	DA	Range, Single Value, Universal	
Study Time	0008,0030	TM	Universal	
Accession Number	0008,0050	SH	Single Value	
Modalities in Study	0008,0061	CS	Single Value	
Referring Physician's Name	0008,0090	PN	Range, Single Value, Universal	
Study Description	0008,1030	LO	Universal	
Patient's Name	0010,0010	PN	Single Value	
Patient ID	0010,0020	LO	Single Value	
Patient's Birth Date	0010,0030	DA	Single Value	
Patient's Birth Time	0010,0032	TM	Single Value, Universal, Wildcard	
Patient's Sex	0010,0040	CS	Single Value, Universal, Wildcard	
Study Instance UID	0020,000D	UI	Single Value, Universal, Wildcard	
Study ID	0020,0010	SH	Single Value, Universal, Wildcard	
Number of Study Related Series	0020,1206	IS	Universal	
Number of Study Related Instances	0020,1208	IS	Universal	
Q/R Series Level				
Series Date	0008,0021	DA	Single Value, Universal	
Series Time	0008,0031	TM	Universal	
Modality	0008,0060	CS	Universal	
Manufacturer	0008,0070	LO	Universal	
Body Part Examined	0018,0015	CS	Universal	
Protocol Name	0018,1030	LO	Single Value	
Series Description	0008,103E	LO	Universal	
Series Number	0020,0011	IS	Universal	
Study Instance UID	0020,000D	UI	Single Value, Universal	
Series Instance UID	0020,000E	UI	Universal	

Study Root Information Model				
Attribute Name	Tag	VR	Type of Matching	Comment
Number of Series Related Instances	0020,1209	IS	Universal	
Performed Procedure Step Start Date	0040,0244	DA	Universal	
Performed Procedure Step Start Time	0040,0245	TM	Single Value	
Request Attributes Sequence	0040,0275	SQ	Universal	
Q/R Image Level				
Image Type	0008,0008	CS	Single Value	
Instance Creation Date	0008,0012	DA	Single Value	
Instance Creation Time	0008,0013	TM	Single Value	
SOP Class UID	0008,0016	UI	Single Value	
SOP Instance UID	0008,0018	UI	Universal	
Contrast/Bolus Agent	0018,0010	LO	Universal	
Slice Thickness	0018,0050	DS	Universal	
KVP	0018,0060	DS	Universal	
Study Instance UID	0020,000D	UI	Single Value	
Series Instance UID	0020,000E	UI	Universal	
Instance Number	0020,0013	IS	Single Value	
Patient Orientation	0020,0020	CS	Universal	
Image Orientation (Patient)	0020,0037	DS	Universal	
Frame of Reference UID	0020,0052	UI	Single Value	
Slice Location	0020,1041	DS	Universal	
Samples per Pixel	0028,0002	US	Single Value	
Photometric Interpretation	0028,0004	CS	Single Value	
Rows	0028,0010	US	Universal	
Columns	0028,0011	US	Universal	
Pixel Spacing	0028,0030	DS	Universal	

Some C-FIND responses will be forwarded before the C-FIND-CANCEL takes effect.

This part of the section includes the dataset specific behavior, i.e. error codes, error and exception handling, time-outs, etc.

Table 45: Status Response

Service Status	Error Code	Further Meaning	Behavior
Success	0000	Matching complete	Matching successful.
Failure	C000	General failure status	Whenever the find operation failed.
Cancel	FE00	Cancel	When receiving a cancel C-FIND request.
Pending	FF00	Pending	For every C-FIND response received.

4.2.1.4.3 (Real-World) Activity – MOVE as SCP

4.2.1.4.3.1 Description and Sequencing of Activities

The Real World activity associated with the C-MOVE command is retrieval of images from the disk and storage of the images to a remote system using a C-STORE command. DICOM Manager will issue a failure status if it is unable to process the transfer request.

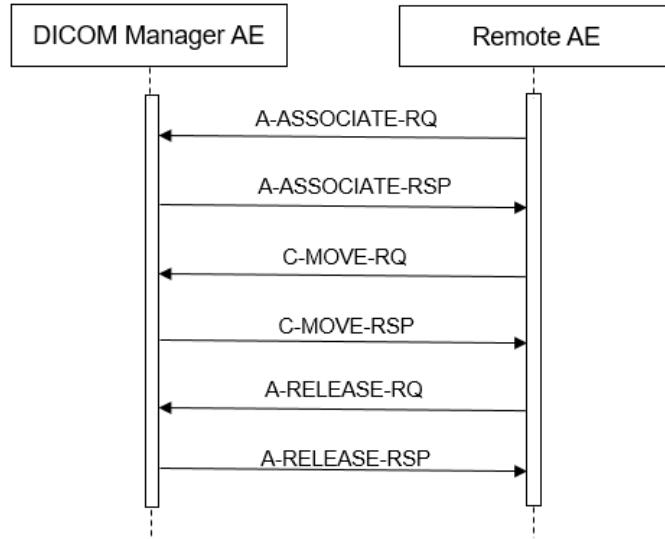

Figure 14: (Real World) Activity - MOVE as SCP

4.2.1.4.3.2 Accepted Presentation Contexts

The presentation contexts are defined in next table.

Table 46: Acceptable Presentation Contexts for (Real-World) Activity – MOVE as SCP

Presentation Context Table					
Abstract Syntax		Transfer Syntax		Role	Extended Negotiation
Name	UID	Name List	UID List		
Study Root QR Information Model - MOVE SOP Class	1.2.840.10008.5.1.4.1.2.2.2	Explicit VR Little Endian	1.2.840.10008.1.2.1	SCP	None
		Implicit VR Little Endian	1.2.840.10008.1.2		

4.2.1.4.3.3 SOP Specific Conformance for Study Root QR Information Model – MOVE SOP Class

This section and sub-section includes the manufacturer SOP and Dataset specific information as well the status codes and their corresponding behavior.

DICOM Manager provides standard conformance to the DICOM V3.0 Query/Retrieve Service Class as an SCP for the following SOP Class: Study Root Query/Retrieve Information Model - MOVE, UID = 1.2.840.10008.5.1.4.1.2.2.2. Prioritization of C-MOVE requests is not supported.

4.2.1.4.3.3.1 Dataset Specific Conformance for Study Root QR Information Model – MOVE SOP Class C-MOVE-SCP

Detail regarding the Dataset Specific response behavior will be reported in this section.

DICOM Manager does not support relational C-MOVE requests. All images requested in the C-MOVE will be sent over a single association.

This part of the section includes the dataset specific behavior, i.e. error codes, error and exception handling, time-outs, etc.

All details regarding the specific conformance, including response behavior of all status codes, both from an application level and communication errors are provided in the following table.

Table 47: Status Response

Service Status	Error Code	Further Meaning	Behavior
Success	0000	Matching complete	Move operation is successful.
Failure	A801	Refused - Move Destination Unknown	Move operation is failed with a failure message in response.
	C000	Error - Unable to Process	Move operation is failed with a failure message in response.
Warning	B000	Sub-operations Complete - One or more Failures	One of the move operation is successful and other fails.
Cancel	FE00	Cancel	Move operation is terminated with a status code in response.

4.2.1.4.4 (Real-World) Activity – Image Import

4.2.1.4.4.1 Description and Sequencing of Activities

The real world activity associated with the C-STORE operation is the storage of the image in the memory of the system upon which DICOM Manager is running in order to make it available for immediate processing by applications. DICOM Manager will issue a failure status if it is unable to store the image in the memory.

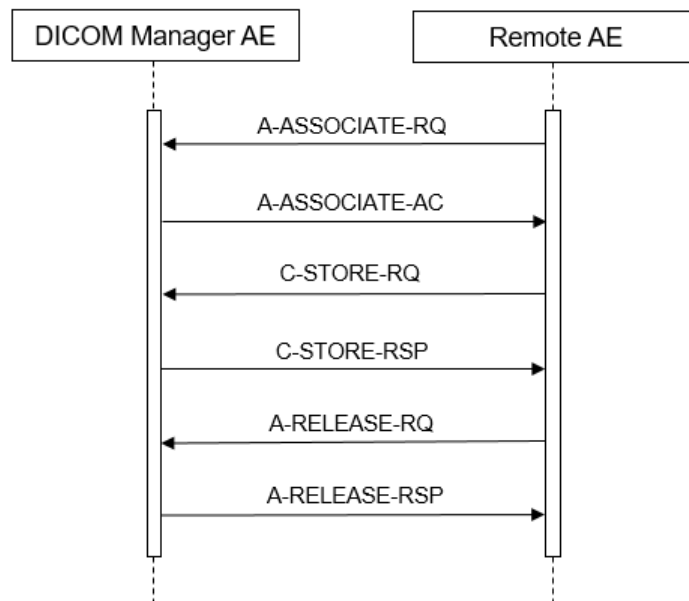

Figure 15: (Real World) Activity – Image Import

4.2.1.4.4.2 Accepted Presentation Contexts

The presentation contexts are defined in next table.

Table 48: Accepted Presentation Contexts for (Real-World) Activity – Image Import

Presentation Context Table					
Abstract Syntax		Transfer Syntax		Role	Extended Negotiation
Name	UID	Name List	UID List		
Computed Radiography Image Storage SOP Class	1.2.840.10008.5.1.4.1.1.1	JPEG Lossless, Non-Hierarchical, FOP (Process 14)	1.2.840.10008.1.2.4.70	SCP	None
		Explicit VR Little Endian	1.2.840.10008.1.2.1		
		Implicit VR Little Endian	1.2.840.10008.1.2		
Digital X-Ray Image Storage - For Pres. SOP Class	1.2.840.10008.5.1.4.1.1.1.11.2.840.10008.5.1.4.1.1.1.1	Explicit VR Little Endian	1.2.840.10008.1.2.1	SCP	None
		Implicit VR Little Endian	1.2.840.10008.1.2		
		JPEG Lossless, Non-Hierarchical, FOP (Process 14)	1.2.840.10008.1.2.4.70		
Digital X-Ray Image Storage - For Proc. SOP Class	1.2.840.10008.5.1.4.1.1.1.1	Explicit VR Little Endian	1.2.840.10008.1.2.1	SCP	None
		Implicit VR Little Endian	1.2.840.10008.1.2		
		JPEG Lossless, Non-Hierarchical, FOP (Process 14)	1.2.840.10008.1.2.4.70		
X-Ray Angiographic Image Storage SOP Class	1.2.840.10008.5.1.4.1.1.12.1	Explicit VR Little Endian	1.2.840.10008.1.2.1	SCP	None
		Implicit VR Little Endian	1.2.840.10008.1.2		
		JPEG Lossless, Non-Hierarchical, FOP (Process 14)	1.2.840.10008.1.2.4.70		
X-Ray Radiofluoroscopic Image Storage SOP Class	1.2.840.10008.5.1.4.1.1.12.2	Explicit VR Little Endian	1.2.840.10008.1.2.1	SCP	None
		Implicit VR Little Endian	1.2.840.10008.1.2		
		JPEG Lossless, Non-Hierarchical, FOP (Process 14)	1.2.840.10008.1.2.4.70		
CT Image Storage SOP Class	1.2.840.10008.5.1.4.1.1.2	Explicit VR Little Endian	1.2.840.10008.1.2.1	SCP	None
		Implicit VR Little Endian	1.2.840.10008.1.2		
		JPEG Lossless, Non-Hierarchical, FOP (Process 14)	1.2.840.10008.1.2.4.70		
Secondary Capture Image Storage SOP Class	1.2.840.10008.5.1.4.1.1.7	Explicit VR Little Endian	1.2.840.10008.1.2.1	SCP	None
		Implicit VR Little Endian	1.2.840.10008.1.2		
		JPEG Lossless, Non-Hierarchical, FOP (Process 14)	1.2.840.10008.1.2.4.70		
X-Ray Radiation Dose SR SOP Class	1.2.840.10008.5.1.4.1.1.88.67	Explicit VR Little Endian	1.2.840.10008.1.2.1	SCP	None
		Implicit VR Little Endian	1.2.840.10008.1.2		
General ECG Waveform Storage SOP Class	1.2.840.10008.5.1.4.1.1.9.1.2	Explicit VR Little Endian	1.2.840.10008.1.2.1	SCP	None
		Implicit VR Little Endian	1.2.840.10008.1.2		
MR Image Storage SOP Class	1.2.840.10008.5.1.4.1.1.4	Explicit VR Little Endian	1.2.840.10008.1.2.1	SCP	None
		Implicit VR Little Endian	1.2.840.10008.1.2		

Presentation Context Table					
Abstract Syntax		Transfer Syntax		Role	Extended Negotiation
Name	UID	Name List	UID List		
		JPEG Lossless, Non-Hierarchical, FOP (Process 14)	1.2.840.10008.1.2.4.70		
Nuclear Medicine Image Storage SOP Class	1.2.840.10008.5.1.4.1.1.20	Explicit VR Little Endian	1.2.840.10008.1.2.1	SCP	None
		Implicit VR Little Endian	1.2.840.10008.1.2		
Digital Intraoral X-Ray Image Storage For Presentation SOP Class	1.2.840.10008.5.1.4.1.1.1.3	Explicit VR Little Endian	1.2.840.10008.1.2.1	SCP	None
		Implicit VR Little Endian	1.2.840.10008.1.2		
		JPEG Lossless, Non-Hierarchical, FOP (Process 14)	1.2.840.10008.1.2.4.70		
Digital Intraoral X-Ray Image Storage For Processing SOP Class	1.2.840.10008.5.1.4.1.1.1.3.1	Explicit VR Little Endian	1.2.840.10008.1.2.1	SCP	None
		Implicit VR Little Endian	1.2.840.10008.1.2		
		JPEG Lossless, Non-Hierarchical, FOP (Process 14)	1.2.840.10008.1.2.4.70		
Grayscale Presentation SOP Class	1.2.840.10008.5.1.4.1.1.11.1	Explicit VR Little Endian	1.2.840.10008.1.2.1	SCP	None
		Implicit VR Little Endian	1.2.840.10008.1.2		
Color Softcopy Presentation State Storage SOP Class	1.2.840.10008.5.1.4.1.1.11.2	Explicit VR Little Endian	1.2.840.10008.1.2.1	SCP	None
		Implicit VR Little Endian	1.2.840.10008.1.2		
Pseudo-Color Softcopy Presentation State Storage SOP Class	1.2.840.10008.5.1.4.1.1.11.3	Explicit VR Little Endian	1.2.840.10008.1.2.1	SCP	None
		Implicit VR Little Endian	1.2.840.10008.1.2		
Blending Softcopy Presentation State Storage SOP Class	1.2.840.10008.5.1.4.1.1.11.4	Explicit VR Little Endian	1.2.840.10008.1.2.1	SCP	None
		Implicit VR Little Endian	1.2.840.10008.1.2		
Real World Value Mapping Storage SOP Class	1.2.840.10008.5.1.4.1.1.67	Explicit VR Little Endian	1.2.840.10008.1.2.1	SCP	None
		Implicit VR Little Endian	1.2.840.10008.1.2		
Raw Data Storage SOP Class	1.2.840.10008.5.1.4.1.1.66	Explicit VR Little Endian	1.2.840.10008.1.2.1	SCP	None
		Implicit VR Little Endian	1.2.840.10008.1.2		
Key Object Selection Document Storage SOP Class	1.2.840.10008.5.1.4.1.1.88.59	Explicit VR Little Endian	1.2.840.10008.1.2.1	SCP	None
		Implicit VR Little Endian	1.2.840.10008.1.2		
Positron Emission Tomography Image Storage SOP Class	1.2.840.10008.5.1.4.1.1.128	Explicit VR Little Endian	1.2.840.10008.1.2.1	SCP	None
		Implicit VR Little Endian	1.2.840.10008.1.2		
		JPEG Lossless, Non-Hierarchical, FOP (Process 14)	1.2.840.10008.1.2.4.70		
Digital Mammography X-Ray	1.2.840.10008.5.1.4.1.1.1.2	Explicit VR Little Endian	1.2.840.10008.1.2.1	SCP	None
		Implicit VR Little Endian	1.2.840.10008.1.2		

Presentation Context Table					
Abstract Syntax		Transfer Syntax		Role	Extended Negotiation
Name	UID	Name List	UID List		
Image Storage For Presentation SOP Class		JPEG Lossless, Non-Hierarchical, FOP (Process 14)	1.2.840.10008.1.2.4.70		
Digital Mammography X-Ray Image Storage For Processing	1.2.840.10008.5.1.4.1.1.1.2.1	Explicit VR Little Endian	1.2.840.10008.1.2.1	SCP	None
		Implicit VR Little Endian	1.2.840.10008.1.2		
RT Image Storage SOP Class	1.2.840.10008.5.1.4.1.1.481.1	JPEG Lossless, Non-Hierarchical, FOP (Process 14)	1.2.840.10008.1.2.4.70	SCP	None
		Explicit VR Little Endian	1.2.840.10008.1.2.1		
RT Dose Storage SOP Class	1.2.840.10008.5.1.4.1.1.481.2	Implicit VR Little Endian	1.2.840.10008.1.2	SCP	None
		JPEG Lossless, Non-Hierarchical, FOP (Process 14)	1.2.840.10008.1.2.4.70		
RT Structure Set Storage SOP Class	1.2.840.10008.5.1.4.1.1.481.3	Explicit VR Little Endian	1.2.840.10008.1.2.1	SCP	None
		Implicit VR Little Endian	1.2.840.10008.1.2		
RT Plan Storage SOP Class	1.2.840.10008.5.1.4.1.1.481.5	Explicit VR Little Endian	1.2.840.10008.1.2.1	SCP	None
		Implicit VR Little Endian	1.2.840.10008.1.2		
Encapsulated PDF Storage SOP Class	1.2.840.10008.5.1.4.1.1.104.1	Explicit VR Little Endian	1.2.840.10008.1.2.1	SCP	None
		Implicit VR Little Endian	1.2.840.10008.1.2		
Spatial Registration Storage SOP Class	1.2.840.10008.5.1.4.1.1.66.1	Explicit VR Little Endian	1.2.840.10008.1.2.1	SCP	None
		Implicit VR Little Endian	1.2.840.10008.1.2		
		JPEG Lossless, Non-Hierarchical, FOP (Process 14)	1.2.840.10008.1.2.4.70		
Multiframe Single Bit Secondary Capture Image Storage	1.2.840.10008.5.1.4.1.1.7.1	Explicit VR Little Endian	1.2.840.10008.1.2.1	SCP	None
		Implicit VR Little Endian	1.2.840.10008.1.2		
Multiframe Grayscale Byte Secondary Capture Image Storage SOP Class	1.2.840.10008.5.1.4.1.1.7.2	Explicit VR Little Endian	1.2.840.10008.1.2.1	SCP	None
		Implicit VR Little Endian	1.2.840.10008.1.2		
Multiframe Grayscale Word Secondary Capture Image Storage	1.2.840.10008.5.1.4.1.1.7.3	Explicit VR Little Endian	1.2.840.10008.1.2.1	SCP	None
		Implicit VR Little Endian	1.2.840.10008.1.2		
Multiframe True Color Secondary Capture Image Storage	1.2.840.10008.5.1.4.1.1.7.4	Explicit VR Little Endian	1.2.840.10008.1.2.1	SCP	None
	1.2.840.10008.5.1.4.1.1.1.3.1	Implicit VR Little Endian	1.2.840.10008.1.2		

Note: All Transfer Syntaxes are configurable in LAN Config, in the order Private-ELE, JPEG, ELE, and ILE.

ELE,JPEG has preference over ILE.

For all SOP classes without pixel data the JPEG transfer syntax will not supported.

4.2.1.4.4.3 SOP Specific Conformance for Storage SOP Class

This section and sub-section includes the manufacturer SOP and Dataset specific information as well the status codes and their corresponding behavior.

DICOM Manager provides standard conformance to the DICOM V3.0 Storage Service Class as a SCP. DICOM Manager conforms to the SOPs of the Storage Service Class at Level 2 (Full - does not discard any data elements). In case of a successful C-STORE, the stored image may be accessed by the processing applications.

4.2.1.4.4.3.1 Dataset Specific Conformance for C-STORE-RSP

Detail regarding the Dataset Specific response behavior will be reported in this section.

This includes the dataset specific behavior, i.e. error codes, error and exception handling, time-outs, etc

Table 49: Status Response

Service Status	Error Code	Further Meaning	Behavior
Success	0000	Successfully stored	Import is successful.
Failure	<xxxx>	Failed	Import fails and the reason for failure is logged.

4.2.2. Print Manager

Details of this specific Application Entity is specified in this section.

4.2.2.1. SOP Classes

This Application Entity provides Standard Conformance to the following SOP Classes.

Table 50: SOP Classes for Print Manager

SOP Class Name	SOP Class UID	SCU	SCP
Basic Color Print Management Meta SOP Class	1.2.840.10008.5.1.1.18	Yes	No
>Basic Film Session SOP Class	1.2.840.10008.5.1.1.1	Yes	No
>Basic Film Box SOP Class	1.2.840.10008.5.1.1.2	Yes	No
>Basic Color Image Box SOP Class	1.2.840.10008.5.1.1.4.1	Yes	No
Basic Grayscale Print Management Meta SOP Class	1.2.840.10008.5.1.1.9	Yes	No
>Basic Film Session SOP Class	1.2.840.10008.5.1.1.1	Yes	No
>Basic Film Box SOP Class	1.2.840.10008.5.1.1.2	Yes	No
>Basic Grayscale Image Box SOP Class	1.2.840.10008.5.1.1.4	Yes	No

Note: Any SOP specific behavior is documented later in the conformance statement in the applicable SOP specific conformance section.

4.2.2.2. Association Policies

Each AE specification contains a description of the general association establishment and acceptance policies of the AE.

4.2.2.2.1 General

The maximum PDU Size that the Print-Manager will use is configurable, with a minimum of 2 Kbytes.

Table 51: DICOM Application Context

Description	Value
Application Context Name	1.2.840.10008.3.1.1.1

4.2.2.2.2 Number of Associations

The number of simultaneous associations that an Application Entity may support as an Initiator or Acceptor is specified.

Print-Manager can have only one open connection at a given time.

Table 52: Number of associations as an Association Initiator for this AE

Description	Value
Maximum number of simultaneous associations	1

4.2.2.2.3 Asynchronous Nature

The implementation supports negotiation of multiple outstanding transactions, along with the maximum number of outstanding transactions supported.

Print-Manager will only allow a single outstanding operation on an association.

Table 53: Asynchronous nature as an Association Initiator for this AE

Description	Value
Maximum number of outstanding asynchronous transactions	1

4.2.2.2.4 Implementation Identifying Information

The value supplied for Implementation Class UID and version name are documented here.

Table 54: DICOM Implementation Class and Version for Print Manager

Implementation Class UID	1.3.46.670589.33.103.11
Implementation Version Name	EBW4.8 for CT

4.2.2.2.5 Communication Failure Handling

Not applicable. iCT, iCT-SP CT System has not implementd communication failure handling for Print Service.

4.2.2.3. Association Initiation Policy

The Application Entity will respond to a received Association rejection as shown in the next table.

Table 55: Association Rejection response

Result	Source	Reason/Diagnosis	Behavior
1 - rejected-permanent	1 - DICOM UL service-user	1 - no-reason-given	The connection is closed.
		2 - application-context-name-not supported	The connection is closed.
		3 - calling-AE-title-not-recognized	The connection is closed.
		7 - called-AE-title-not-recognized	The connection is closed.
	2 - DICOM UL service-provider (ACSE related function)	1 - no-reason-given	The connection is closed.
		2 - protocol-version-not-supported	The connection is closed.

Result	Source	Reason/Diagnosis	Behavior
	3 - DICOM UL service-provider (Presentation related function)	1 - temporary-congestion	The connection is closed.
		2 - local-limit-exceeded	The connection is closed.
2 - rejected-transient	1 - DICOM UL service-user	1 - no-reason-given	The connection is closed.
		2 - application-context-name-not-supported	The connection is closed.
		3 - calling-AE-title-not-recognized	The connection is closed.
		7 - called-AE-title-not-recognized	The connection is closed.
	2 - DICOM UL service-providerz (ACSE related function)	1 - no-reason-given	The connection is closed.
		2 - protocol-version-not-supported	The connection is closed.
	3 - DICOM UL service-provider (Presentation related function)	1 - temporary-congestion	The connection is closed.
		2 - local-limit-exceeded	The connection is closed.

The behavior of the AE on receiving an association abort is summarized in next table.

Table 56: Association Abort Handling

Source	Reason/Diagnosis	Behavior
0 - DICOM UL service-user (initiated abort)	0 - reason-not-specified	The connection is closed.
2 - DICOM UL service-provider (initiated abort)	0 - reason-not-specified	The connection is closed.
	1 - unrecognized-PDU	The connection is closed.
	2 - unexpected-PDU	The connection is closed.
	4 - unrecognized-PDU-parameter	The connection is closed.
	5 - unexpected-PDU-parameter	The connection is closed.
	6 - invalid-PDU-parameter-value	The connection is closed.

4.2.2.3.1 (Real-World) Activity – Print Management as SCU

4.2.2.3.1.1 Description and Sequencing of Activities

After selecting the print destination (out of choice list of configured printers) and some print parameters (depending on the configuration and the selected printer; these values can be configured too), Print-Manager initiates an association when a print job is submitted to a DICOM printer (when the user clicks on the print button in the film view). Jobs to different printers are performed simultaneously. Normally, when the job is completed and there are no other jobs to the same printer, the Print manager closes the association with an A-RELEASE request.

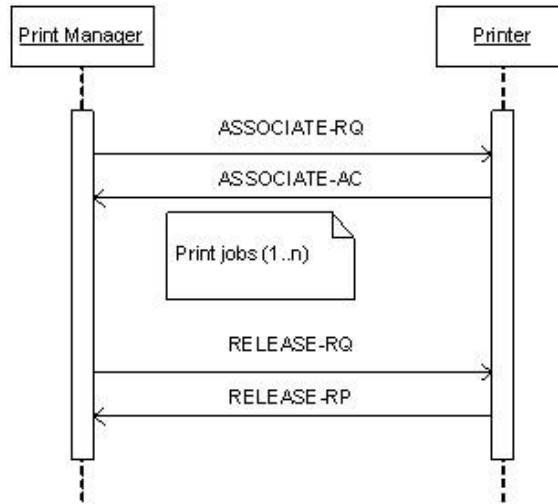

Figure 16: (Real World) Activity – Print Manager Initiates

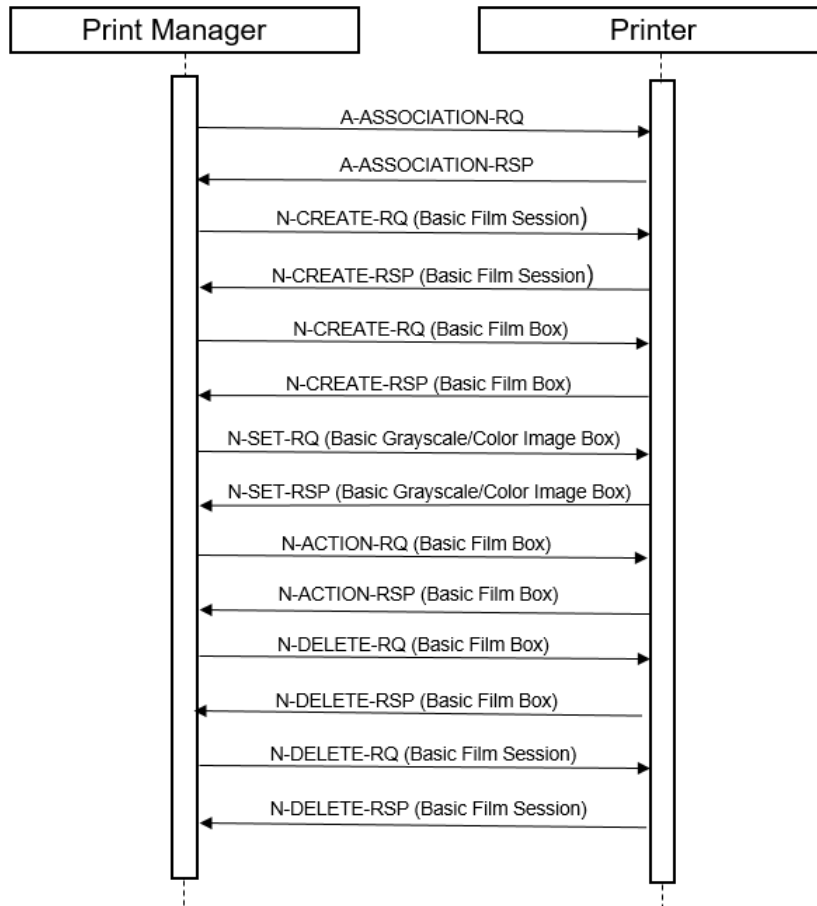

Figure 17: (Real World) Activity – Print Management as SCU

4.2.2.3.1.2 Proposed Presentation Contexts

The presentation contexts are defined in next table.

Table 57: Proposed Presentation Contexts for (Real-World) Activity – Print Management As SCU

Presentation Context Table					
Abstract Syntax		Transfer Syntax		Role	Extended Negotiation
Name	UID	Name List	UID List		
Basic Color Print Management Meta SOP Class	1.2.840.10008.5.1.1.18			SCU	None
>Basic Film Session SOP Class	1.2.840.10008.5.1.1.1	Explicit VR Little Endian	1.2.840.10008.1.2.1	SCU	None
		Implicit VR Little Endian	1.2.840.10008.1.2		
>Basic Film Box SOP Class	1.2.840.10008.5.1.1.2	Explicit VR Little Endian	1.2.840.10008.1.2.1	SCU	None
		Implicit VR Little Endian	1.2.840.10008.1.2		
>Basic Color Image Box SOP Class	1.2.840.10008.5.1.1.4.1	Explicit VR Little Endian	1.2.840.10008.1.2.1	SCU	None
		Implicit VR Little Endian	1.2.840.10008.1.2		
Basic Grayscale Print Management Meta SOP Class	1.2.840.10008.5.1.1.9			SCU	None
>Basic Film Session SOP Class	1.2.840.10008.5.1.1.1	Explicit VR Little Endian	1.2.840.10008.1.2.1	SCU	None
		Implicit VR Little Endian	1.2.840.10008.1.2		
>Basic Film Box SOP Class	1.2.840.10008.5.1.1.2	Explicit VR Little Endian	1.2.840.10008.1.2.1	SCU	None
		Implicit VR Little Endian	1.2.840.10008.1.2		
>Basic Grayscale Image Box SOP Class	1.2.840.10008.5.1.1.4	Explicit VR Little Endian	1.2.840.10008.1.2.1	SCU	None
		Implicit VR Little Endian	1.2.840.10008.1.2		

Note: The only supported Transfer Syntaxes for printing are ELE and ILE.

This section specifies each IOD created (including private IOD's).

Abbreviations used in the Module table for the column "Presence of Value" are:

- ALWAYS The attribute is always present with a value
- EMPTY The attribute is always present without any value (attribute sent zero length)
- VNAP The attribute is always present and its Value is Not Always Present (attribute sent zero length if no value is present)
- ANAP The attribute is present under specified condition – if present then it will always have a value

The abbreviations used in the Module table for the column "Source" are:

- AUTO The attribute value is generated automatically
- CONFIG The attribute value source is a configurable parameter
- COPY The attribute value source is another SOP instance
- FIXED The attribute value is hard-coded in the application
- IMPLICIT The attribute value source is a user-implicit setting
- MPPS The attribute value is the same as that use for Modality Performed Procedure Step
- MWL The attribute value source is a Modality Worklist
- USER The attribute value source is explicit user input

4.2.2.3.1.3 SOP Specific Conformance for Basic Film Session SOP Class of the Basic Color Print Management Meta SOP Class

This section and sub-section includes the manufacturer SOP and Dataset specific information as well the status codes and their corresponding behavior.

The Printer process conforms to the Basic Film Session SOP Class. The following DIMSE service elements are supported:

- N-CREATE
- N-DELETE

4.2.2.3.1.3.1 Dataset Specific Conformance for Basic Film Session SOP Class N-CREATE-SCU

Details regarding the Dataset Specific response behavior will be reported in this section.

Table 58: Basic Film Session Presentation Module

Attribute Name	Tag	VR	Value	Presence of Value	Source	Comments
Number of Copies	2000,0010	IS		ALWAYS	USER	Value between 1-100
Print Priority	2000,0020	CS	AUTO, HIGH, LOW, MED	ANAP	USER	
Medium Type	2000,0030	CS	BLUE FILM, CLEAR FILM, PAPER	ALWAYS	CONFIG, USER	
Film Destination	2000,0040	CS	MAGAZINE, PROCESSOR	ALWAYS	CONFIG, USER	

Table 59: Status Response

Service Status	Error Code	Further Meaning	Behavior
Success	0000	Success	Successful print job status is displayed on UI.
Warning	<xxxx>	All warning numbers	Print job continues with a warning code logged.
Failure	<xxxx>	All error numbers	Print job is terminated and error message is logged.

4.2.2.3.1.3.2 Dataset Specific Conformance for Basic Film Session SOP Class N-DELETE-SCU

Detail regarding the Dataset Specific response behavior will be reported in this section.

Table 60: Status Response

Service Status	Error Code	Further Meaning	Behavior
Success	0000	Film Session successfully created	Successful print job status is displayed on UI.
Failure	<xxxx>	Error code	Print job is terminated and error message is logged.

4.2.2.3.1.4 SOP Specific Conformance for Basic Film Box SOP Class of the Basic Color Print Management Meta SOP Class

This section and sub-sections includes the manufacturer SOP and Dataset specific information as well the status codes and their corresponding behavior.

The Printer process conforms to the Basic Film Box Sop Class. The following DIMSE service elements are supported:

- N-CREATE
- N-ACTION
- N-DELETE

4.2.2.3.1.4.1 Dataset Specific Conformance for Basic Film Box SOP Class N-CREATE-SCU

Table 61: Basic Film Box Presentation Module

Attribute Name	Tag	VR	Value	Presence of Value	Source	Comments
Image Display Format	2010,0010	ST	STANDARD\1,1	ALWAYS	CONFIG	
Film Orientation	2010,0040	CS	LANDSCAPE, PORTRAIT	ALWAYS	CONFIG, USER	
Film Size ID	2010,0050	CS		ALWAYS	CONFIG, USER	As in printer configuration file.
Trim	2010,0140	CS	NO, YES	ALWAYS	CONFIG, USER	
Magnification Type	2010,0060	CS		ALWAYS	CONFIG	As in printer configuration file.
Min Density	2010,0120	US		ALWAYS	CONFIG	As in printer configuration file.
Trim	2010,0140	CS	NO, YES	ALWAYS	CONFIG, USER	
Configuration Information	2010,0150	ST		ALWAYS	CONFIG	As in printer configuration file.
Referenced Film Session Sequence	2010,0500	SQ		ALWAYS	AUTO	
>Referenced SOP Class UID	0008,1150	UI		ALWAYS	AUTO	UID of Parent Film Session.
>Referenced SOP Instance UID	0008,1155	UI		ALWAYS	AUTO	

Table 62: Basic Film Box Relationship Module

Attribute Name	Tag	VR	Value	Presence of Value	Source	Comments
Referenced Film Session Sequence	2010,0500	SQ		ALWAYS	AUTO	
>Referenced SOP Class UID	0008,1150	UI		ALWAYS	AUTO	UID of Parent Film Session.
>Referenced SOP Instance UID	0008,1155	UI		ALWAYS	AUTO	

Table 63: Status Response

Service Status	Error Code	Further Meaning	Behavior
Success	0000	Film Box successfully created	Operation is completed successfully
Warning	0116	Attributes out of range	Print job continues with a warning code logged.
Failure	0106	Invalid Attribute Value	Print job is terminated and error message is logged.
	0105	No Such Attribute	Print job is terminated and error message is logged.

4.2.2.3.1.4.2 Dataset Specific Conformance for Basic Film Box SOP Class N-ACTION-SCU

Table 64: DICOM Command Response Status Handling Behavior for Basic Film Box N-ACTION

Service Status	Error Code	Further Meaning	Behavior
Success	0000	Film accepted for printing	Operation is completed successfully.

Service Status	Error Code	Further Meaning	Behavior
Failure	0119	Specified SOP Instance is not a member of the specified SOP class	Print job is terminated and error message is logged.
Warning	B603	Film Box SOP Instance hierarchy does not contain Image Box SOP Instances	Print job continues with a warning code logged.
	B604	Image Size is larger than Image Box Size - The Image has been de-magnified	Print job continues with a warning code logged.
	B609	Image Size is larger than Image Box Size - The Image has been cropped to fit	Print job continues with a warning code logged.
	B60A	Image Size or combined Print Image Size is larger than Image Box Size - The Image or combined Print Image has been decimated to fit	Print job continues with a warning code logged.

4.2.2.3.1.4.3 Dataset Specific Conformance for Basic Film Box SOP Class N-DELETE-SCU

Table 65: Status Response

Service Status	Error Code	Further Meaning	Behavior
Success	0000	Film Session successfully created	Operation is completed successfully.
Other than Success	<xxxx>	Any other status then success	Print job remains in the queue manager with status failed

4.2.2.3.1.5 SOP Specific Conformance for Basic Color Image Box SOP Class of the Basic Color Print Management Meta SOP Class

This section and sub-section includes the manufacturer SOP and Dataset specific information as well the status codes and their corresponding behavior.

The Printer process conforms to the Color Image Box Sop Class. The following DIMSE service element is supported: N-SET.

4.2.2.3.1.5.1 Dataset Specific Conformance for Basic Color Image Box SOP Class N-SET-SCU

Details regarding the Dataset Specific response behavior will be reported in this section.

Table 66: Image Box Pixel Presentation Module

Attribute Name	Tag	VR	Value	Presence of Value	Source	Comments
Image Box Position	2020,0010	US	1	ALWAYS	AUTO	
Basic Color Image Sequence	2020,0111	SQ		ALWAYS	AUTO	
>Samples per Pixel	0028,0002	US	3	ALWAYS	AUTO	
>Photometric Interpretation	0028,0004	CS	RGB	ALWAYS	AUTO	
>Planar Configuration	0028,0006	US	0, 1	ALWAYS	AUTO	
>Rows	0028,0010	US		ALWAYS	AUTO	As in printer configuration file.
>Columns	0028,0011	US		ALWAYS	AUTO	As in printer configuration file.
>Pixel Aspect Ratio	0028,0034	IS		ALWAYS	AUTO	Must be present if not 1/1.
>Bits Allocated	0028,0100	US	8	ALWAYS	AUTO	
>Bits Stored	0028,0101	US	8	ALWAYS	AUTO	

Attribute Name	Tag	VR	Value	Presence of Value	Source	Comments
>High Bit	0028,0102	US	7	ALWAYS	AUTO	
>Pixel Representation	0028,0103	US	0	ALWAYS	AUTO	
>Pixel Data	7FE0,0010	OW/OB		ALWAYS	AUTO	

This part of the section includes the dataset specific behavior, i.e. error codes, error and exception handling, time-outs, etc.

Table 67: DICOM Command Response Status Handling Behavior for Basic Color Image Box N-SET

Service Status	Error Code	Further Meaning	Behavior
Success	0000	Image successfully stored in Image Box	Operation is completed successfully.
Warning	0107	Attribute list error	Print job continues with a warning code logged.
Failure	0106	Invalid Attribute Value	Print job is terminated and error message is logged.
	0105	No Such Attribute	Print job is terminated and error message is logged.

4.2.2.3.1.6 SOP Specific Conformance for Basic Film Session SOP Class of the Basic Grayscale Print Management Meta SOP Class

This section and sub-section includes the manufacturer SOP and Dataset specific information as well the status codes and their corresponding behavior.

The Printer process conforms to the Basic Film Session SOP Class. The following DIMSE service element is supported:

- N-CREATE
- N-DELETE

4.2.2.3.1.6.1 Dataset Specific Conformance for Basic Film Session SOP Class N-CREATE-SCU

Table 68: Basic Film Session Presentation Module

Attribute Name	Tag	VR	Value	Presence of Value	Source	Comments
Number of Copies	2000,0010	IS		ALWAYS	CONFIG, USER	Value between 1-100
Print Priority	2000,0020	CS	AUTO, HIGH, LOW, MED	ALWAYS	CONFIG, USER	
Medium Type	2000,0030	CS	BLUE FILM, CLEAR FILM, PAPER	ALWAYS	USER	
Film Destination	2000,0040	CS	MAGAZINE, PROCESSOR	ANAP	USER	

This part of the section includes the dataset specific behavior, i.e. error codes, error and exception handling, time-outs, etc.

Table 69: Status Response

Service Status	Error Code	Further Meaning	Behavior
Success	0000	Success	Successful print job status is displayed on UI.
Warning	<xxxx>	All warning numbers	Print job continues with a warning code logged.
Failure	<xxxx>	All error numbers	Print job is terminated and error message is logged.

4.2.2.3.1.6.2 Dataset Specific Conformance for Basic Film Session SOP Class N-DELETE-SCU

Detail regarding the Dataset Specific response behavior will be reported in this section.

This part of the section includes the dataset specific behavior, i.e. error codes, error and exception handling, time-outs, etc.

Table 70: Status Response

Service Status	Error Code	Further Meaning	Behavior
Success	0000	Film Session successfully created	Successful print job status is displayed on UI.
Failure	<xxxx>	Error code	Print job is terminated and error message is logged.

4.2.2.3.1.7 SOP Specific Conformance for Basic Film Box SOP Class of the Basic Grayscale Print Management Meta SOP Class

This section and sub-sections includes the manufacturer SOP and Dataset specific information as well the status codes and their corresponding behavior.

The Printer process conforms to the Basic Film Box Sop Class. The following DIMSE service elements are supported:

- N-CREATE
- N-ACTION
- N-DELETE

4.2.2.3.1.7.1 Dataset Specific Conformance for Basic Film Box SOP Class N-CREATE-SCU

Detail regarding the Dataset Specific response behavior will be reported in this section.

Table 71: Basic Film Box Presentation Module

Attribute Name	Tag	VR	Value	Presence of Value	Source	Comment
Image Display Format	2010,0010	ST	STANDARD\1,1	ALWAYS	CONFIG	
Film Orientation	2010,0040	CS	LANDSCAPE, PORTRAIT	ALWAYS	CONFIG, USER	
Film Size ID	2010,0050	CS		ALWAYS	CONFIG, USER	As in printer configuration file.
Magnification Type	2010,0060	CS		ALWAYS	CONFIG	As in printer configuration file.
Min Density	2010,0120	US		ALWAYS	CONFIG	As in printer configuration file.
Max Density	2010,0130	US		ALWAYS	CONFIG	As in printer configuration file.
Trim	2010,0140	CS	NO, YES	ALWAYS	CONFIG, USER	
Configuration Information	2010,0150	ST		ALWAYS	CONFIG	As in printer configuration file.

Table 72: Basic Film Box Relationship Module

Attribute Name	Tag	VR	Value	Presence of Value	Source	Comments
Referenced Film Session Sequence	2010,0500	SQ		ALWAYS	AUTO	

Attribute Name	Tag	VR	Value	Presence of Value	Source	Comments
>Referenced SOP Class UID	0008,1150	UI		ALWAYS	AUTO	UID of Parent Film Session.
>Referenced SOP Instance UID	0008,1155	UI		ALWAYS	AUTO	

This part of the section includes the dataset specific behavior, i.e. error codes, error and exception handling, time-outs, etc.

Table 73: Status Response

Service Status	Error Code	Further Meaning	Behavior
Success	0000	Film Box successfully created	Operation is completed successfully
Warning	0116	Attributes out of range	Print job continues with a warning code logged.
Failure	0106	Invalid Attribute Value	Print job is terminated and error message is logged.
	0105	No Such Attribute	Print job is terminated and error message is logged.

4.2.2.3.1.7.2 Dataset Specific Conformance for Basic Film Box SOP Class N-ACTION-SCU

Detail regarding the Dataset Specific response behavior will be reported in this section.

This part of the section includes the dataset specific behavior, i.e. error codes, error and exception handling, time-outs, etc.

Table 74: Status Response

Service Status	Error Code	Further Meaning	Behavior
Success	0000	Film accepted for printing	Operation is completed successfully.
Failure	0119	Specified SOP Instance is not a member of the specified SOP class	Print job is terminated and error message is logged.
Warning	B603	Film Box SOP Instance hierarchy does not contain Image Box SOP Instances	Print job continues with a warning code logged.
	B604	Image Size is larger than Image Box Size - The Image has been de-magnified	Print job continues with a warning code logged.
	B609	Image Size is larger than Image Box Size - The Image has been cropped to fit	Print job continues with a warning code logged.
	B60A	Image Size or combined Print Image Size is larger than Image Box Size - The Image or combined Print Image has been decimated to fit	Print job continues with a warning code logged.

4.2.2.3.1.7.3 Dataset Specific Conformance for Basic Film Box SOP Class N-DELETE-SCU

Detail regarding the Dataset Specific response behavior will be reported in this section.

This part of the section includes the dataset specific behavior, i.e. error codes, error and exception handling, time-outs, etc.

Table 75: Status Response

Service Status	Error Code	Further Meaning	Behavior
Success	0000	Film Session successfully created	Operation is completed successfully.
Other than Success	<xxxx>	Any other status then success	Print job remains in the queue manager with status failed

4.2.2.3.1.8 SOP Specific Conformance for Basic Grayscale Image Box SOP Class of the Basic Grayscale Print Management Meta SOP Class

This section and sub-section includes the manufacturer SOP and Dataset specific information as well the status codes and their corresponding behavior.

The Printer process conforms to the Color Image Box Sop Class. The following DIMSE service element is supported: N-SET.

4.2.2.3.1.8.1 Dataset Specific Conformance for Basic Grayscale Image Box SOP Class N-SET-SCU

Detail regarding the Dataset Specific response behavior will be reported in this section.

Table 76: Image Box Pixel Presentation Module

Attribute Name	Tag	VR	Value	Presence of Value	Source	Comments
Image Box Position	2020,0010	US	1	ALWAYS	AUTO	
Basic Grayscale Image Sequence	2020,0110	SQ		ALWAYS	AUTO	
>Samples per Pixel	0028,0002	US	1, 3	ALWAYS	AUTO	
>Photometric Interpretation	0028,0004	CS	MONOCHROME2	ALWAYS	AUTO	
>Rows	0028,0010	US		ALWAYS	AUTO	As in printer configuration file.
>Columns	0028,0011	US		ALWAYS	AUTO	As in printer configuration file.
>Pixel Aspect Ratio	0028,0034	IS		ALWAYS	AUTO	Must be present if not 1/1.
>Bits Allocated	0028,0100	US	8	ALWAYS	AUTO	
>Bits Stored	0028,0101	US	8	ALWAYS	AUTO	
>High Bit	0028,0102	US	7	ALWAYS	AUTO	
>Pixel Representation	0028,0103	US	0	ALWAYS	AUTO	
>Pixel Data	7FE0,0010	OW/OB		ALWAYS	AUTO	

This part of the section includes the dataset specific behavior, i.e. error codes, error and exception handling, time-outs, etc.

Table 77: DICOM Command Response Status Handling Behavior for Basic Grayscale Image Box N-SET

Service Status	Error Code	Further Meaning	Behavior
Success	0000	Image successfully stored in Image Box	Operation is completed successfully.
Warning	0107	Attribute list error	Print job continues with a warning code logged.
Failure	0106	Invalid Attribute Value	Print job is terminated and error message is logged.
	0105	No Such Attribute	Print job is terminated and error message is logged.

4.2.2.3.1.9 SOP Specific Conformance for Printer SOP Class of the Basic Color Print Management Meta SOP Class

Not applicable, Printer SOP Class is not supported.

4.2.2.3.1.9.1 Dataset Specific Conformance for Printer SOP Class N-EVENT-REPORT-SCU

Not applicable, Printer SOP Class is not supported.

4.2.2.3.1.10 SOP Specific Conformance for Printer SOP Class of the Basic Grayscale Print Management Meta SOP Class

Not applicable, Printer SOP Class is not supported.

4.2.2.3.1.10.1 Dataset Specific Conformance for Printer SOP Class N-EVENT-REPORT-SCU

Not applicable, Printer SOP Class is not supported.

4.2.2.4. Association Acceptance Policy

Not applicable, Print Manager AE never accepts an association.

4.3. Network Interfaces

4.3.1. Physical Network Interfaces

The System provides only DICOM V3.0 TCP/IP Network Communication Support as defined in PS 3.8 of the DICOM standard.

iCT, iCT-SP inherits its TCP/IP stack from Windows 7 (i.e. the operating system platform).

iCT, iCT-SP supports a single network interface Ethernet ISO 8802-3.

With standard supported physical medium include:

IEEE 802.3-1995, 10BASE-T

IEEE 802.3-1995, 100BASE-TX (Fast Ethernet)

IEEE 802.3, 1000BASE-X (Fiber Optic Gigabit Ethernet).

4.3.2. Additional Protocols

Additional protocols such as used for network management are not applicable.

4.3.3. IPv4 and IPv6 Support

The iCT, iCT-SP CT supports both IPv4 and IPv6 networks communication.

4.4. Configuration

Any implementation's DICOM conformance may be dependent upon configuration, which takes place at the time of installation. Issues concerning configuration are addressed in this section.

4.4.1. AE Title/Presentation Address Mapping

The iCT, iCT-SP CT system is configured by means of a configuration program. This program is accessible at start-up of the iCT, iCT-SP system. It is password protected and intended to be used by the administrator onsite or Philips Customer Support Engineers only.

Per configuration in LAN Config Tool, the system allows to accept associations from a range of IP addresses. With incoming association requests the system allows acceptance of a range of defined IP addresses which is configurable in the LAN Config application.

An important installation issue is the translation from AE title to presentation address. With incoming association requests the system allows acceptance of a range of defined IP addresses which is configurable in the LAN Config application. How this is performed is described in this section. The system is not IP or AE title sensitive.

4.4.1.1. Local AE Titles

The local AE title mapping and configuration are specified as:

Table 78: AE Title Configuration

Application Entity	Default AE Title	Default TCP/IP Port
DICOM Manager	DATABASE	104 (configurable)
Print Manager	DATABASE	104 (configurable)

4.4.1.2. Remote AE Title/Presentation Address Mapping

Remote AE Title, IP-Address, Port-number, supported DICOM Services and Transfer Syntaxes are freely configurable.

4.4.2. Parameters

The specification of important operational parameters, their default value and range (if configurable) is specified here.

Table 79: Configuration Local Parameters Table

Local Parameter	Configurable	Default Value
Basic Parameters		
Network - Computer Name	Yes	<hostname> Set during installation
Network - IP	Yes	(0.0.0.0)
Network - NetMask	Yes	
Network - Gateway	Yes	(0.0.0.0)
System Port	Yes	104
System - AE Title	Yes	DATABASE
MPPS Repair mode	Yes	Checked
Advanced Parameters		
IP Filter Mode	Yes	Configured Device IPS
Auto Import - Enable	Yes	Unchecked
Auto Import - Input Folder Name	Yes	No Value
Auto Import - Failed Folder Name	Yes	No Value
Auto Import - Import Type	Yes	DICOM
Auto Import – Polling Interval In Seconds	Yes	60
Verify Service Timeout in Seconds	Yes	60
Query Service Timeout in Seconds	Yes	60
Storage Service Timeout in Seconds	Yes	300
Storage Commitment Service Timeout in Seconds	Yes	300
Retrieve Service Timeout in Seconds	Yes	300
Print Service Timeout in Seconds	Yes	300

Table 80: Configuration Remote Parameters Table

Remote Parameter	Configurable	Default Value
Basic Parameters – Remote Node		
Device Name	Yes	-
Port	Yes	-
AE-Title	Yes	-
Visible	Yes	Visible
Enable	Yes	Checked

Remote Parameter	Configurable	Default Value
Archived	Yes	Unchecked
CharSet	Yes	Unchecked
Large Archive	Yes	Unchecked
Max PDU	Yes	65536
ARTimer	Yes	5
Transfer Syntax	Yes	ELE and ILE enabled
Advanced Parameters - Query		
Association Timeout In Seconds	Yes	300
Lowest Support Level	Yes	Image
Query Response Size	Yes	100
Advanced Parameters - Store		
Association Timeout In Seconds	Yes	120
Advanced Parameters - Retrieve		
Association Timeout In Seconds	Yes	0
Advanced Parameter - Storage Commitment		
Association Timeout In Seconds	Yes	120
Advanced Parameter – Worklist Query		
Association Timeout In Seconds	Yes	120
Query Response Size	Yes	100
Advanced Parameter – MPPS		
Association Timeout In Seconds	Yes	120

Table 81: Configuration General Print Parameters Table

General Print Parameter	Configurable	Default Value
Advanced Parameter		
Association Timeout In Seconds	Yes	150

Printers are configurable by a selection of the default printer types. Every printer type has a fixed configuration, but can be extended with new ones. The default printer settings are defined in the printer configuration file.

5. Media Interchange

5.1. Implementation model

The implementation model identifies the DICOM Application Entities for Media in specific implementation and relates the Application Entities to Real-World Activities.

5.1.1. Application Data Flow Diagram

As part of the implementation model, an application data flow diagram is included. The next Figure shows the media interchange application data flow as a functional overview of the Media AE for DICOM CD and DVD.

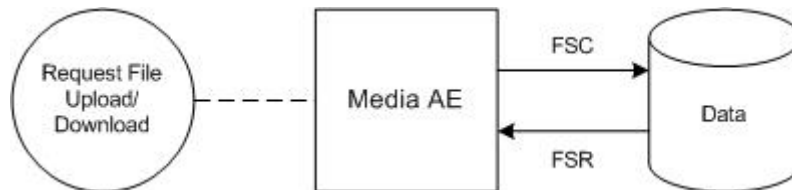

Figure 18: Media Interchange Application Data Flow Diagram

The Media AE acts as a FSR when reading the directory of the medium. The Media AE acts as a FSC when writing the selected images in a patient folder onto the CD-R / DVD medium.

The Media AE acts as a FSR, for CD-R and DVD, when reading the directory of the medium. The Media AE acts as a FSC for CD-R and DVD, when writing the selected images in a patient folder onto the medium.

5.1.2. Functional Definitions of AE's

This section contains a functional definition for each local Application Entity. It's described in general terms the functions to be performed by the AE, and the DICOM services used to accomplish these functions.

The iCT, iCT-SP CT system can create and Read CD/DVD.

The Media AE in an iCT, iCT-SP CT system supports the following functions for CD and DVD as FSR:

- Read the DICOMDIR File from the medium (representing the directory of the DICOM File(s) as recorded on the medium). This information may be displayed as an ordered list of icon images and, if present, with pertinent identifying information (patient name, etc.).
- Read the selected image from the medium and display it on the monitor of the View Station. This information is displayed as an ordered list of frames of the selected image or as a dynamic review of the selected image.

Remark: only CD's and DVD's that were created according to the application profiles STD-GEN-CD, STD-CTMR-CD and STD-CTMR-DVD are supported as FSR by the iCT, iCT-SP system.

And for CD and DVD as FSC:

- Initialize the medium.
- Write a DICOM File-set onto the medium.
- Create a DICOMDIR File.
- Extend the DICOM File-set and update the DICOMDIR File accordingly. (DICOM Media Storage Service Class).

5.1.3. Sequencing of Real World Activities

A Real World Activity of the Media AE is: The user selects a set of objects to write to the CD/DVD. Then the CD /DVD will be created with the selected objects. Once the CD/DVD has been created, the user can read this CD/DVD on the iCT, iCT-SP CT system or for transport to another device for reading.

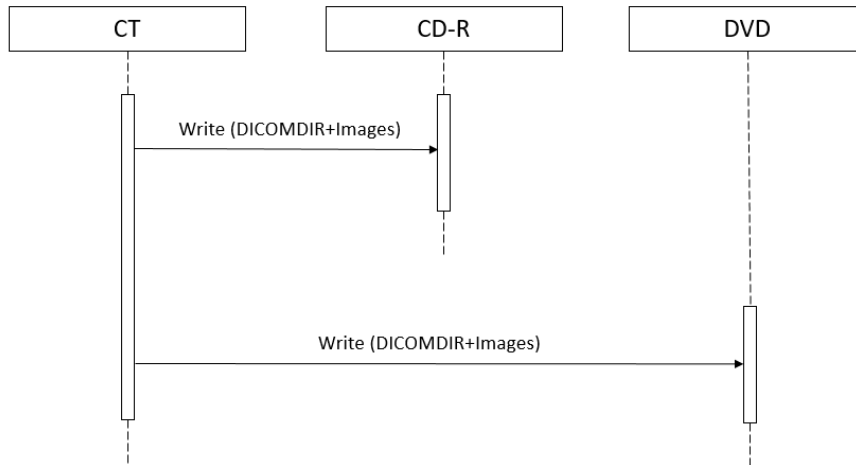

Figure 19: (Real World) Activity - Media

Another Real World Activity of the Media AE is: A CD/DVD from another system or previously created CD/DVD can be read by the iCT, iCT-SP system.

Remark: DVD’s that were created following the definition of the STD-GEN-DVD-JPEG application profile are not supported for reading since iCT, iCT-SP does not support JPEGBaseline, JPEGFOP14 and JPEG2000 compression.

After data is written to DVD, the DVD is finalized; the finalized DVD can now be read on mostly every DVD reader.

5.1.4. File Meta Information for Implementation Class and Version

This section contains the values of the file Meta Information that pertain to the Application Entity (see PS 3.10). These are:

- Source Application Entity Title,
- Private Information Creator UID,
- Private Information.

The Application Entity title is registered into the DICOM File Meta Information header and is supported by the CD/DVD-Writer (CD/DVD write option) acting as a FSC.

Table 82: File Meta Information for the Media AE

Implementation Class UID	1.3.46.670589.33.103.11
Implementation Version Name	EBW4.8 for CT

5.2. AE Specifications

This section in the DICOM Conformance Statement specifies a set of Media Application Entities.

5.2.1. Media - Specification

iCT, iCT-SP CT systems (for writing and reading) provides standard conformance to:

- DICOM media Storage Service and File Format ([DICOM] PS 3.10);
- Media Storage Application Profiles ([DICOM] PS 3.11); and
- Media Formats and Physical Media for Media Interchange ([DICOM] PS 3.12) for Reading (FSR) and Writing (FSC).

iCT, iCT-SP CT system does not support multi-session writes to CD/DVD's.

Supported media:

- CD: CD-R and CD-RW with the profile STD-GEN-CD.
- DVD: DVD-R, DVD+R, DVD-RW and DVD+RW with the profile: STD-GEN-DVD-JPEG as FSR.

The supported Application Profiles, their roles and the Service Class (SC) options, all defined in DICOM terminology, are listed in the next Table.

Table 83: AE Media AE related Application Profiles, RWA activities and roles

Supported Application Profile	Identifier	Real-World Activities	Roles
CT/MR Studies on CD-R	STD-CTMR-CD	Create File-set	FSC
		Read File-set	FSR
		Display Directory	DD
General Purpose CD-R Interchange	STD-GEN-CD	Create File-set	FSC
		Read File-set	FSR
		Display Directory	DD
CT/MR Studies on DVD Media	STD-CTMR-DVD	Create File-set	FSC
		Read File-set	FSR
		Display Directory	DD
General Purpose DVD Interchange with JPEG	STD-GEN-DVD-JPEG	Create File-set	FSC
		Read File-set	FSR
		Display Directory	DD

5.2.1.1. DICOM File Meta Information

Table below denotes the DICOM file meta attributes included in the DICOMDIR that are created by the iCT, iCT-SP system.

Table 84: DICOM Part 10 File Meta Information

Attribute Name	Tag	Notes
File Preamble	N/A	All bytes are set to 00H
DICOM Prefix	N/A	Set to DICOM Prefix "DICM"
File Meta Information Group Length	(0002,0000)	
File Meta Information Version	(0002,0001)	Set to 0001H
Media Storage SOP Class UID	(0002,0002)	1.2.840.10008.1.3.10
Media Storage SOP Instance UID	(0002,0003)	iCT, iCT-SP CT system generated UID
Transfer Syntax UID	(0002,0010)	Set to Explicit VR Little Endian 1.2.840.10008.1.2.1
Implementation Class UID	(0002,0012)	Set to "1.3.46.670589.33.103.11"
Implementation Version Name	(0002,0013)	Set to "EBW4.8 for CT"

Table 85: DICOMDIR Attributes

Attribute Name	Tag	Notes
File Set ID	0004,1130	
Offset of the First Directory Record of the Root Directory Entity	0004,1200	
Offset of the Last Directory Record of the Root Directory Entity	0004,1202	
File Set Consistency Flag	0004,1212	
Directory Record Sequence	0004,1220	
>Offset of the Next Directory Record	0004,1400	

Attribute Name	Tag	Notes
>Record In-use Flag	0004,1410	
>Offset of Referenced Lower-Level Directory Entity	0004,1420	
>Directory Record Type	0004,1430	
>Referenced File ID	0004,1500	
>Referenced SOP Class UID in File	0004,1510	
>Referenced Transfer Syntax UID in File	0004,1512	
Patient Level		
Offset Of The Next Dir Record	0004,1400	
Record In Use Flag	0004,1410	
Offset of Referenced Lower-Level Directory Entity	0004,1420	
Directory Record Type	0004,1430	
Specific Character Set	0008,0005	
Patient's Name	0010,0010	
Patient ID	0010,0020	
Study Level		
Offset Of The Next Dir Record	0004,1400	
Record In Use Flag	0004,1410	
Offset Of Ref Lower Level Dir Entity	0004,1420	
Directory Record Type	0004,1430	
Specific Character Set	0008,0005	
Study Date	0008,0020	
Study Time	0008,0030	
Accession Number	0008,0050	
Study Description	0008,1030	
Study Instance UID	0020,000D	
Study ID	0020,0010	
Modalities in Study	0008,0061	
Institution Name	0008,0080	
Referring Physician's Name	0008,0090	
Operators Name	0008,1070	
Patient's Birth Date	0010,0030	
Patient's Sex	0010,0040	
Number Of Study Related Series	0020,1206	
Number Of Study Related Instances	0020,1208	
Requested Procedure ID	0040,1001	
Series Level		
Offset Of The Next Directory Record	0004,1400	
Record In-Use Flag	0004,1410	
Offset of Referenced Lower-Level Directory Entity	0004,1420	
Directory Record Type	0004,1430	
Specific Character Set	0008,0005	
Series Date	0008,0021	
Content Date	0008,0023	
Series Time	0008,0031	
Content Time	0008,0033	

Attribute Name	Tag	Notes
Modality	0008,0060	
Manufacturer	0008,0070	
Series Instance UID	0020,000E	
Series Number	0020,0011	
Series Description	0008,103E	
Body Part Examined	0018,0015	
Protocol Name	0018,1030	
Number of Series Related Instances	0020,1209	
Image Level		
Offset Of The Next Directory Record	0004,1400	
Record In-Use Flag	0004,1410	
Offset Of Referenced Lower-Level Directory Entity	0004,1420	
Directory Record Type	0004,1430	
Referenced File ID	0004,1500	
Referenced SOP Class UID In File	0004,1510	
Referenced SOP Instance UID In File	0004,1511	
Referenced Transfer Syntax UID In File	0004,1512	
Specific Character Set	0008,0005	
Instance Number	0020,0013	
Image Type	0008,0008	
Instance Creation Date	0008,0012	
Instance Creation Time	0008,0013	
SOP Class UID	0008,0016	
SOP Instance UID	0008,0018	
Acquisition Date	0008,0022	
Acquisition Time	0008,0032	
Content Date	0008,0023	
Content Time	0008,0033	
Acquisition Number	0020,0012	
Slice Thickness	0018,0050	
KVP	0018,0060	
Reconstruction Diameter	0018,1100	
Gantry/Detector Tilt	0018,1120	
Angular Position	0018,1141	
Image Position (Patient)	0020,0032	
Image Orientation (Patient)	0020,0037	
Frame of Reference UID	0020,0052	
Slice Location	0020,1041	
Image Comments	0020,4000	
Samples per Pixel	0028,0002	
Photometric Interpretation	0028,0004	
Rows	0028,0010	
Columns	0028,0011	
Pixel Spacing	0028,0030	
Bits Allocated	0028,0100	

5.2.1.2. Real-World Activities

The AE specification contains a description of the Real-World Activities, which invoke the particular AE.

5.2.1.2.1 RWA - Read File-set

When an image transfer from CD or DVD is initiated then the Media AE acts as an FSR using the interchange option to import SOP Instances from the CD or DVD medium.

5.2.1.2.1.1 Media Storage Application Profile

The media AE supports the RWA Read File-set for the STD-CT/MR studies on CD, the STD-GEN-CD, the General Purpose DVD Interchange with JPEG and CT/MR Studies on DVD Media application profiles.

5.2.1.2.1.1.1 Options

Not applicable. No Options are implemented by the system.

5.2.1.2.2 RWA - Create File-set

This Media Application Entity has a File-set Creator functionality which is describe here.

When an image transfer to CD/DVD is initiated then the Media AE acts as an FSC using the interchange option to export SOP Instances from the local database to a CD/DVD medium.

5.2.1.2.2.1 Media Storage Application Profile

The application Profile that is used by this Media Application Entity is specified in this section.

As depicted in the table in section 5.2.1, the Media AE supports the RWA Write Images for the STD-CTMR-CD, STD-GEN-CD, STD-GEN-DVD-JPEG and the STD-CTMR-DVD Application Profile.

The DICOMDIR file will be extended when new images are written. In case some attributes are not present in an image but are specified as mandatory in the DICOMDIR definition in DICOM Media, a generated value will be filled in.

Implementation remarks and restrictions

When writing the DICOMDIR records, key values are generated when no value of the corresponding attribute is supplied, according to the following tables.

Table 86: Generated keys

Key	Tag	Generated Value
Study Keys		
Study Date	(0008,0020)	Date on which this Study was created.
Study Time	(0008,0030)	Time on which this Study was created.
Series Keys		
Series Number	(0020,0011)	1
Image Keys		
Instance Number	(0020,0013)	1 (if empty)

The data selected to write to the media must fit on the currently inserted media. If it does not fit, an error is generated and it is up to the operator to re-select a smaller amount of data to be written to the media. The system will not request additional media or write across multiple media.

5.2.1.2.2.1.1 Options

Not applicable. No Options are implemented by the system.

5.2.1.2.3 RWA - Display Directory

When a database open action is initiated on the CD/DVD then the Media AE acts as an FSR using the interchange option to read the DICOMDIR of the CD/DVD media.

This will result in an overview of the patients, studies, series and images on the iCT, iCT-SP screen.

5.2.1.2.3.1 Media Storage Application Profile

The media AE supports the RWA Display Directory for the STD-CT/MR studies on CD, the STD-GEN-CD, the General Purpose DVD Interchange with JPEG and CT/MR Studies on DVD Media application profiles.

5.2.1.2.3.1.1 Options

The mandatory DICOMDIR keys are required for the correct display of directory information. The display is structured according to the DICOM Composite Information Model: Patient, Study, Series, and Image.

The DICOM standard specifies certain attributes of the DICOMDIR as mandatory. However, these attributes may not be mandatory for the related SOP class IOD. For those attributes the default values apply.

5.3. Augmented and Private Application Profiles

Not supported. Augmented and private application profiles are not implemented by the system.

5.4. Media Configuration

Any configuration issues may be found in the Networking Section 4.4 Configuration.

6. Support of Character Sets

Any support for character sets in Network and Media services is described here.

Table 87: Supported DICOM Character Sets

Character Set Description	Defined Term	ESC Sequence	ISO Registration Number	Code Element	Character Set
Latin alphabet No. 1	ISO_IR 100	-	ISO-IR 100	G1	Supplementary set of ISO 8859
		-	ISO-IR 6	G0	ISO 646
Chinese	GB18030	-	GB18030	-	-
Default repertoire	-	-	ISO-IR 6	G0	ISO 646

7. Security

7.1. Security Profiles

iCT, iCT-SP CT allows the use of either a conventional (non-secure) DICOM communication or a secure DICOM communication based on the Transport Layer Security (TLS) protocol. If configured iCT, iCT-SP CT supports the following security measures:

- Secure authentication of a node
- Integrity and confidentiality of transmitted data
- Generation of audit trail records access control and user authentication

7.1.1. Security use Profiles

Not Applicable. Security use Profiles are not implemented by the system.

7.1.2. Security Transport Connection Profiles

The TLS Component is a “mode of operation” of iCT, iCT-SP CT and will be used for nodes that can authenticate each other before they communicate over sockets. TLS 1.2 can only be used using TCP. Node authentication and encryption are only possible when the node has:

- a “private and public key”;
- a self-signed certificate or certificate signed by a Certificate Authority; and
- a list of certificates with which the system wants to communicate.

Furthermore, the TLS component may communicate using the following Cipher Suites:

TLS_DHE_RSA_WITH_AES_128_GCM_SHA256
 TLS_DHE_RSA_WITH_AES_256_GCM_SHA384
 TLS_ECDHE_RSA_WITH_AES_128_GCM_SHA256
 TLS_ECDHE_RSA_WITH_AES_256_GCM_SHA384
 TLS_ECDHE_RSA_WITH_AES_256_CBC_SHA384
 TLS_ECDHE_RSA_WITH_AES_256_CBC_SHA
 TLS_RSA_WITH_AES_256_CBC_SHA256
 TLS_RSA_WITH_AES_256_GCM_SHA384
 TLS_ECDHE_RSA_WITH_AES_128_CBC_SHA256
 TLS_ECDHE_RSA_WITH_AES_128_CBC_SHA
 TLS_RSA_WITH_AES_128_CBC_SHA256
 TLS_RSA_WITH_AES_128_GCM_SHA256
 TLS_RSA_WITH_3DES_EDE_CBC_SHA
 TLS_RSA_WITH_AES_256_CBC_SHA
 TLS_RSA_WITH_AES_128_CBC_SHA
 TLS_RSA_WITH_AES_128_GCM_SHA256
 TLS_DHE_RSA_WITH_AES_256_CBC_SHA
 TLS_DHE_RSA_WITH_AES_128_CBC_SHA
 TLS_RSA_WITH_RC4_128_SHA
 TLS_RSA_WITH_RC4_128_MD5

In case no encryption is used the data is signed and hashed: integrity is present and confidentiality is not present.

Certificates

If two systems communicate with each other, one system will be listening on a port (server node) while the other system sets up a connection (client node). The certificate this server node will send to the other client node is the server certificate. The client node initiates the communication and the certificate that the client

node is sending to the server is the client certificate. (Server Client Authentication) The following TLS Certification checks will be done (TLS Handshake). The machine (either server or client) that will send its certificate will choose the certificate according to Common Name (CN) value in the Subject-field. This name is case-sensitive. All present certificates should have unique CN names.

The server verifies:

- that the client certificate is a valid X.509 certificate;
- that the client certificate is either signed by a CA or is self-signed;
- that the client certificate is in the list of trusted certificates;
- that the client certificate is valid (present time is between "Valid from" and "Valid to" fields of the X.509 certificate);
- that the client certificate has the correct purpose (at least the Client Authenticate purpose).

The client verifies:

- that the server certificate is a valid X.509 certificate;
- that the server certificate either is signed by a CA or is self-signed;
- that the server certificate is in the list of trusted certificates;
- that the server certificate is valid (present time is between "Valid from" and "Valid to" fields of the X.509 certificate);
- that the server certificate has the correct purpose (at least Server Authenticate purpose).

In the TLS component no verification is done on:

- revocation of certificates;
- limiting the connection to a limited set of IP-addresses.

Additional information: The value in the Subject-field is determined in the certificate request. The CA will sign the request in case it accepts the values that are present in the request. The CN value can be: IP-number, hostname or hostname. Domain. The value in the CN-field must be equal to the value that is used in making a connection to the server. In case the name is specified as hostname. Domain that same value should be specified during connect. In the ideal situation the name-IP-number translation will be dealt with by the DNS in the hospital. This check is case-insensitive.

Figure below presents the message flow of TLS handshake supported by iCT, iCT-SP.

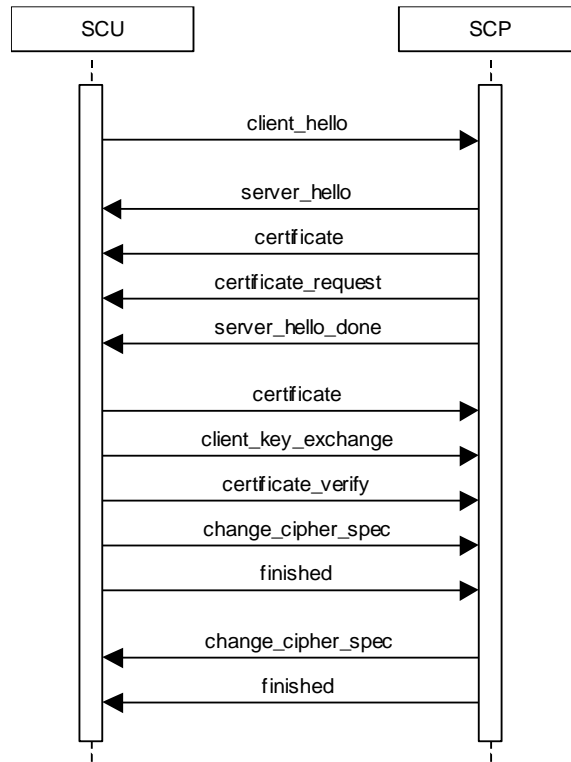

Figure 20: Message flow of TLS handshake

7.1.3. Digital Signature Profiles

Not Applicable. Digital Signature Profiles are not implemented by the System.

7.1.4. Media Storage Security Profiles

Not applicable. Media Storage Security Profiles are not implemented by the System.

7.1.5. Attribute Confidentiality Profiles

No instances of the Encrypted Attributes Data Set are created. No Transfer Syntaxes are supported for encoding/decoding of Encrypted Attributes Data Sets.

The table below lists the attributes that are replaced during the identification process.

The terms used to describe the replacement value can be read as below:

- Empty: The attribute will have a value of zero length, is cleared by iCT, iCT-SP system.
- Copied: Attribute has same value as original.

Table 88: Basic Application Level Confidentiality Profile Attributes

Attribute Name	Tag	VR	Replacement Value
Specific Character Set	0008,0005	CS	Copied from original
Instance Creator UID	0008,0014	UI	[empty]
SOP Instance UID	0008,0018	UI	New created UID
Study Date	0008,0020	DT	Replaced by new value
Series Date	0008,0021	DT	Replaced by new value
Acquisition Date	0008,0022	DT	Replaced by new value
Content Date	0008,0023	DT	Replaced by new value

Attribute Name	Tag	VR	Replacement Value
Study Time	0008,0030	TM	Copied from original
Series Time	0008,0031	TM	Copied from original
Acquisition Time	0008,0032	TM	Copied from original
Content Time	0008,0033	TM	Copied from original
Accession Number	0008,0050	SH	[empty]
Institution Name	0008,0080	LO	[empty]
Institution Address	0008,0081	ST	[empty]
Referring Physician's Name	0008,0090	PN	[empty]
Referring Physician's Address	0008,0092	ST	[empty]
Referring Physician's Telephone Numbers	0008,0094	SH	[empty]
Station Name	0008,1010	SH	[empty]
Study Description	0008,1030	LO	[empty]
Series Description	0008,103E	LO	[empty]
Institutional Department Name	0008,1040	LO	[empty]
Physician(s) of Record	0008,1048	PN	[empty]
Performing Physicians' Name	0008,1050	PN	[empty]
Name of Physician(s) Reading Study	0008,1060	PN	[empty]
Operators' Name	0008,1070	PN	[empty]
Admitting Diagnoses Description	0008,1080	LO	[empty]
Manufacturers Model Name	0008,1090	LO	[empty]
Referenced Study Sequence	0008,1110	SQ	[empty]
Referenced Patient Sequence	0008,1120	SQ	[empty]
Referenced Image Sequence	0008,1140	SQ	Replaced by new value
Derivation Description	0008,2111	ST	[empty]
Patient's Name	0010,0010	PN	Initials - Last and First Name component can be changed by user
Patient ID	0010,0020	LO	[empty] - Can be changed by user
Patient's Birth Date	0010,0030	DA	Replaced by new value
Patient's Birth Time	0010,0032	TM	Replaced by new value
Patient's Sex	0010,0040	CS	Copied from original
Other Patient ID's	0010,1000	LO	[empty]
Other Patient Names	0010,1001	PN	[empty]
Patient's Age	0010,1010	AS	[empty]
Patient Size	0010,1020	DS	Copied from original
Patient Weight	0010,1030	DS	Copied from original
Medical Record Locator	0010,1090	LO	[empty]
Medical Alerts	0010,2000	LO	[empty]
Ethnic Group	0010,2160	SH	[empty]
Occupation	0010,2180	SH	[empty]
Additional Patient's History	0010,21B0	LT	[empty]
Pregnancy Status	0010,21C0	US	[empty]
Patient Comment	0010,4000	LT	[empty]
Device Serial Number	0018,1000	LO	[empty]
Protocol Name	0018,1030	LO	[empty]
Study Instance UID	0020,000D	UI	New created UID

Attribute Name	Tag	VR	Replacement Value
Series Instance UID	0020,000E	UI	New created UID
Study ID	0020,0010	SH	New created UID
Frame of Reference UID	0020,0052	UI	New created UID
Synchronization Frame of Reference UID	0020,0200	UI	New created UID
Image Comments	0020,4000	LT	[empty]
Requesting Physician	0032,1032	PN	[empty]
Requesting Service	0032,1033	LO	[empty]
Requested Procedure Description	0032,1060	LO	[empty]
Requested Procedure Code Sequence	0032,1064	SQ	[empty]
Admission ID	0038,0010	LO	[empty]
Special Needs	0038,0050	LO	[empty]
Current Patient Location	0038,0300	LO	[empty]
Patient State	0038,0500	LO	[empty]
Scheduled Procedure Step Sequence	0040,0100	SQ	[empty]
Performed Procedure Step Start Date	0040,0244	DA	[empty]
Performed Procedure Step Start Time	0040,0245	TM	[empty]
Series Description	0008,103E	LO	[empty]
Institutional Department Name	0008,1040	LO	[empty]
Performed Procedure Step ID	0040,0253	SH	Copied from original
Performed Procedure Step Description	0040,0254	LO	Copied from original
Request Attributes Sequence	0040,0275	SQ	[empty]
Requested Procedure ID	0040,1001	SH	[empty]
Names of Intended recipients of Results	0040,1010	PN	[empty]
Requested Procedure Comments	0040,1400	LT	[empty]
Imaging Service Request Comments	0040,2400	LT	[empty]
UID	0040,A124	UI	New created UID
Content Sequence	0040,A730	SQ	[empty]
Storage Media File Set UID	0088,0140	UI	[empty]
Referenced Frame of Reference UID	3006,0024	UI	[empty]
Related Frame of Reference UID	3006,00C2	UI	[empty]

7.1.6. Network Address Management Profiles

Not applicable. Network Address Management Profiles are not implemented by the System.

7.1.7. Time Synchronization Profiles

iCT, iCT-SP CT System conforms to the Basic Time Synchronization Profile as NTP Client. iCT, iCT-SP CT System does support secure transactions.

7.1.8. Application Configuration Management Profiles

Not applicable. Application Configuration Management Profiles is not implemented by the system.

7.1.9. Audit Trail Profiles

iCT, iCT-SP CT creates audit messages according to the IHE ATNA Integration Profile. These messages may contain information that identifies the patient. The following messages will be created and sent to a central Audit Record Repository:

Table 89: List of supported events

Audit Event Trigger	Description	Message DICOM PS 3.15 A.5.3
Actor-start-stop	When iCT, iCT-SP CT system starts or shuts down	Application Activity
Begin-storing-instances	When an examination is being transferred from the iCT, iCT-SP CT system to a remote network node	Begin Transferring DICOM Instances
Instances-Stored	When an examination is transferred from the iCT, iCT-SP CT system to a remote network node	DICOM Instances Transferred
Study-used	Study is created, modified, accessed, or deleted	DICOM Instances Accessed
User Authentication	When the user logs in or logs out	User Authentication.
Security Alert	When an authentication of a secure node during TLS negotiation fails, e.g. due to an invalid certificate and configuration and other changes	Security Alert
PHI-export	When printing job is started or export on media e.g CD, DVD	Export
PHI-import	Any import of PHI from removable media.	Import
Image Availability Query	A query has been initiated from patient directory to a remote node	Query
Audit Log Used	The audit trail repository has been accessed or modified by something other than the arrival of audit trail messages.	Audit Log Used
Instance deleted	If SOP Instances are deleted from a specific study. One event covers all instances deleted for the particular study	DICOM Study Deleted

7.2. Association Level Security

Not applicable. Association level Security profiles are not implemented by the System.

7.3. Application Level Security

iCT, iCT-SP CT System does not support any specific application level security measures.

- The Application which gives access to Patient records and DICOM communication requires Login with Username and Password.
- The system is used within a secured environment. It is assumed that a secured environment includes at a minimum.
 - The OS is solidified by white-listing applications and files. Not white-listed executable files, libraries, drivers, Java apps, ActiveX controls, scripts, and other code are blocked.
 - Firewall or router protections to ensure that only approved external hosts have network access to iCT, iCT-SP CT System.
 - Firewall or router protections to ensure that iCT, iCT-SP CT System only has network access to approved external hosts and services.
 - Any communication with external hosts outside the locally secured environment can be configured to use secure network channels.

Other network security procedures such as automated intrusion detection may be appropriate in some environments.

Additional security features may be established by the local security policy and are beyond the scope of this conformance statement.

8. Annexes of application "iCT, iCT-SP"

8.1. IOD Contents

8.1.1. Created SOP Instance

General Rules

This section specifies each IOD related to conventional images created by the CT scanner application or conventional images created by the viewing applications running on the iCT, iCT-SP system or conventional images created by the Spectral CT viewer application running on the iCT, iCT-SP v4.1.10 system. IOD's related to the spectral images are discussed at section 8.1.2.

The viewing applications running on iCT, iCT-SP (CT Viewer, Cardiac CT viewer,...) can create additional DICOM images that are based on the loaded CT images in these viewers. Most of the attributes or even the whole modules (Patient, General Study, etc.) are just copied from the source CT images.

DICOM Overlays are only created for saved Secondary Capture SOP Class images. When images with ROI, Annotations, etc. (group 50xx) are saved as DICOM Secondary Captures, the 50xx groups attributes are converted into DICOM Overlays attributes (group 60xx). In case SCP does not support group 60xx attributes - the iCT, iCT-SP 4.1.10 has a configurable option (in LAN Config) to burn the overlays into the pixel data thus allowing any PACS to display them.

For images created by the viewing applications running on iCT, iCT-SP 4.1.10, the attribute "Burned In Annotation", has the value "YES" in case the option "save display" is used in the save image window. The attribute "Burned In Annotation" has the value "NO" for derived objects, if saved with "hide titles" (for images that are saved as secondary capture SOP Class object).

For Value Representation (VR) equal to Patient's Name (PN), the leading spaces into the Patient's Name will be treated as insignificant for matching purposes.

From the Patient's Name only the first 32 characters are displayed into the Quick View Viewer.

A Time attribute contains a string of characters of the format "hhmmss.frac". The Fractional part is always 3 decimal places.

Derived CT Image Attributes

Image Plane module attributes:

- All derived CT images, except curved (panoramic) slab, contain the Image Position (0028,0032) and Image Orientation (0028,0037) attributes.
- All derived CT (including curve slab) images contain the Pixel Spacing (0028,0030) and Slice Thickness (0018,0050) attributes.
- Non-Square pixels are not supported by "iCT, iCT-SP viewers".

Export Converters

A number of configurable export converters allow the system to modify certain IOD when sent to specific SCP.

Color-to-Monochrome Converter

The Color (24-bits) SC IOD is converted to a monochrome 8-bit or 12 bit SC IOD, configurable by FSE. A new UID is generated for the converted image.

Burn Overlays Converter

The overlays on the images are burned into the Pixel data for the image and the DICOM overlay groups (50xx and 60xx) are removed from the IOD. This convertor works only on Secondary Capture IOD's.

Convert Philips Tags to CCA Cardiac Tags

Private Philips DICOM attributes are converted to allow the IOD to be processed by non-Philips systems.

Copied modules to the derived IOD's

The following table lists the modules that are always copied from the source images when the created SOP Class IOD is the same as the source SOP Class IOD.

Table 90: Modules copied to the derived IOD's table

Information Entity	Module Name
Patient	Patient Module
	Clinical Trial Subject Module
Study	General Study Module
	Patient Study Module
	Clinical Trial Study Modules
Series	General Series Modules
	Clinical Trial Series Module
Frame of Reference	Frame of Reference Module
Equipment	General Equipment Module

This section specifies each IOD created (including private IOD's). It should specify the attribute name, tag, VR, and value. The value should specify the range and source (e.g. user input, Modality Worklist, automatically generated, etc.). For content items in templates, the range and source of the concept name and concept values should be specified. Whether the value is always present or not shall be specified.

Abbreviations used in the IOD tables for the column "Presence of Module" are:

- ALWAYS The module is always present
- CONDITIONAL The module is used under specified condition

Abbreviations used in the Module table for the column "Presence of Value" are:

- ALWAYS The attribute is always present with a value
- EMPTY The attribute is always present without any value (attribute sent zero length)
- VNAP The attribute is always present and its Value is Not Always Present (attribute sent zero length if no value is present)
- ANAP The attribute is present under specified condition – if present then it will always have a Value

The abbreviations used in the Module table for the column "Source" are:

- AUTO The attribute value is generated automatically
- CONFIG The attribute value source is a configurable parameter
- COPY The attribute value source is another SOP instance
- FIXED The attribute value is hard-coded in the application
- IMPLICIT The attribute value source is a user-implicit setting
- MPPS The attribute value is the same as that use for Modality Performed Procedure Step
- MWL The attribute value source is a Modality Worklist
- USER The attribute value source is explicit user input

Items in the Value and Comment columns in the following tables are filled in where appropriate to further clarify the use or meaning of each attribute beyond the definition provided by the DICOM Standard. All

others are left blank for ease of use. See PS3.3 of the DICOM Standard for the complete attribute definitions.

8.1.1.1. List of created SOP Classes

Table 91: List of created SOP Classes

SOP Class Name	SOP Class UID
CT Image Storage SOP Class	1.2.840.10008.5.1.4.1.1.2
Secondary Capture Image Storage SOP Class	1.2.840.10008.5.1.4.1.1.7
General ECG Waveform Storage SOP Class	1.2.840.10008.5.1.4.1.1.9.1.2
X-Ray Radiation Dose SR	1.2.840.10008.5.1.4.1.1.88.67

8.1.1.1.1 CT Image Storage SOP Class

Table 92: SOP Class Modules

Information Entity	Module	Presence
Patient	Patient Module	ALWAYS
Study	General Study Module	ALWAYS
	Patient Study Module	CONDITIONAL
Series	General Series Module	ALWAYS
Frame of Reference	Frame of Reference Module	ALWAYS
Equipment	General Equipment Module	ALWAYS
Acquisition	General Acquisition Module	ALWAYS
Image	General Image Module	ALWAYS
	General Reference Module	ALWAYS
	Image Plane Module	ALWAYS
	Image Pixel Module	ALWAYS
	Contrast/Bolus Module	CONDITIONAL
	CT Image Module	ALWAYS
	VOI LUT Module	CONDITIONAL
	SOP Common Module	ALWAYS

Table 93: Patient Module

Attribute Name	Tag	VR	Value	Presence of Value	Source	Comment
Patient's Name	0010,0010	PN		VNAP	MWL, USER	
Patient ID	0010,0020	LO		VNAP	MWL, USER	
Patient's Birth Date	0010,0030	DA		VNAP	MWL, USER	
Patient's Sex	0010,0040	CS		VNAP	MWL, USER	
Patient Comments	0010,4000	LT		ANAP	MWL, USER	
Referenced Patient Sequence	0008,1120	SQ		ANAP	MWL, USER	
>Referenced SOP Class UID	0008,1150	UI		ALWAYS	AUTO	
>Referenced SOP Instance UID	0008,1155	UI		ALWAYS	AUTO	

Table 94: General Study Module

Attribute Name	Tag	VR	Value	Presence of Value	Source	Comment
Study Date	0008,0020	DA		VNAP	AUTO	
Study Time	0008,0030	TM		VNAP	AUTO	
Accession Number	0008,0050	SH		VNAP	MWL, USER	
Referring Physician's Name	0008,0090	PN		VNAP	MWL, USER	
Study Description	0008,1030	LO		ANAP	AUTO	
Study Instance UID	0020,000D	UI		ALWAYS	AUTO	
Study ID	0020,0010	SH		VNAP	AUTO	
Procedure Code Sequence	0008,1032	SQ		ANAP	AUTO	
>Code Value	0008,0100	SH		ALWAYS	AUTO	
>Coding Scheme Designator	0008,0102	SH		ALWAYS	AUTO	
>Code Meaning	0008,0104	LO		ALWAYS	AUTO	
Referenced Study Sequence	0008,1110	SQ		VNAP	AUTO	

Table 95: Patient Study Module

Attribute Name	Tag	VR	Value	Presence of Value	Source	Comment
Admitting Diagnoses Description	0008,1080	LO		ANAP	MWL, USER	
Patient's Age	0010,1010	AS		ANAP	MWL, USER	
Patient's Size	0010,1020	DS		ANAP	MWL, USER	
Patient's Weight	0010,1030	DS		ANAP	MWL, USER	

Table 96: General Series Module

Attribute Name	Tag	VR	Value	Presence of Value	Source	Comment
Series Date	0008,0021	DA		ANAP	AUTO	
Series Time	0008,0031	TM		ANAP	AUTO	
Modality	0008,0060	CS	CT	ALWAYS	AUTO	
Series Description	0008,103E	LO		ANAP	AUTO	
Operators' Name	0008,1070	PN		ANAP	AUTO	
Referenced Performed Procedure Step Sequence	0008,1111	SQ		ANAP	AUTO	
>Referenced SOP Class UID	0008,1150	UI		ALWAYS	AUTO	
>Referenced SOP Instance UID	0008,1155	UI		ALWAYS	AUTO	
Body Part Examined	0018,0015	CS		ANAP	AUTO	
Protocol Name	0018,1030	LO		ANAP	AUTO	
Patient Position	0018,5100	CS		ANAP	AUTO	
Series Instance UID	0020,000E	UI		ALWAYS	AUTO	
Series Number	0020,0011	IS		VNAP	AUTO	
Performed Procedure Step Start Date	0040,0244	DA		ANAP	AUTO	

Attribute Name	Tag	VR	Value	Presence of Value	Source	Comment
Performed Procedure Step Start Time	0040,0245	TM		ANAP	AUTO	
Performed Procedure Step ID	0040,0253	SH		ANAP	AUTO	
Performed Procedure Step Description	0040,0254	LO		ANAP	AUTO	
Performed Protocol Code Sequence	0040,0260	SQ		ANAP	AUTO	
>Code Value	0008,0100	SH		ALWAYS	AUTO	
>Coding Scheme Designator	0008,0102	SH		ALWAYS	AUTO	
>Code Meaning	0008,0104	LO		ALWAYS	AUTO	
Request Attributes Sequence	0040,0275	SQ		ANAP	AUTO	
>Requested Procedure Description	0032,1060	LO		ANAP	AUTO	
>Requested Procedure Code Sequence	0032,1064	SQ		ANAP	AUTO	
>>Code Value	0008,0100	SH		ALWAYS	AUTO	
>>Coding Scheme Designator	0008,0102	SH		ALWAYS	AUTO	
>>Code Meaning	0008,0104	LO		ALWAYS	AUTO	
>Scheduled Procedure Step Description	0040,0007	LO		ANAP	AUTO	
>Scheduled Protocol Code Sequence	0040,0008	SQ		ANAP	AUTO	
>>Code Value	0008,0100	SH		ALWAYS	AUTO	
>>Coding Scheme Designator	0008,0102	SH		ALWAYS	AUTO	
>>Code Meaning	0008,0104	LO		ALWAYS	AUTO	
>Scheduled Procedure Step ID	0040,0009	SH		ANAP	AUTO	
>Requested Procedure ID	0040,1001	SH		ANAP	AUTO	
>Reason for the Requested Procedure	0040,1002	LO		ALWAYS	AUTO	
>Reason for Requested Procedure Code Sequence	0040,100A	SQ		ALWAYS	AUTO	
>>Code Value	0008,0100	SH		ALWAYS	AUTO	
>>Coding Scheme Designator	0008,0102	SH		ALWAYS	AUTO	
>>Code Meaning	0008,0104	LO		ALWAYS	AUTO	

Table 97: Frame of Reference Module

Attribute Name	Tag	VR	Value	Presence of Value	Source	Comment
Frame of Reference UID	0020,0052	UI		ALWAYS	AUTO	
Position Reference	0020,1040	LO		VNAP	AUTO	

Indicator

Table 98: General Equipment Module

Attribute Name	Tag	VR	Value	Presence of Value	Source	Comment
Manufacturer	0008,0070	LO	Philips	VNAP	FIXED	
Institution Name	0008,0080	LO		ANAP	CONFIG	
Institution Address	0008,0081	ST		ANAP	CONFIG, USER	
Station Name	0008,1010	SH		ANAP	CONFIG	
Institutional Department Name	0008,1040	LO		ANAP	CONFIG	
Manufacturer's Model Name	0008,1090	LO	iCT - iCT 256/CT 6000 iCT-SP - iCT SP	ANAP	FIXED	
Device Serial Number	0018,1000	LO		ANAP	AUTO, CONFIG	
Software Version(s)	0018,1020	LO	4.1.10	ANAP	FIXED	

Table 99: General Acquisition Module

Attribute Name	Tag	VR	Value	Presence of Value	Source	Comment
Acquisition Date	0008,0022	DA		ANAP	AUTO	
Acquisition Time	0008,0032	TM		ANAP	AUTO	
Acquisition DateTime	0008,002A	DT		ANAP	AUTO	
Irradiation Event UID	0008,3010	UI		ANAP	AUTO	
Acquisition Number	0020,0012	IS		ANAP	AUTO	

Table 100: General Image Module

Attribute Name	Tag	VR	Value	Presence of Value	Source	Comment
Image Type	0008,0008	CS		ANAP	AUTO	
Content Date	0008,0023	DA		VNAP	AUTO	
Content Time	0008,0033	TM		VNAP	AUTO	
Image Comments	0020,4000	LT		ALWAYS	FIXED	
Instance Number	0020,0013	IS		ALWAYS	AUTO	
Burned In Annotation	0028,0301	CS		ANAP	AUTO	YES if patient information is burned in
Lossy Image Compression	0028,2110	CS		ANAP	AUTO	

Table 101: General Reference Module

Attribute Name	Tag	VR	Value	Presence of Value	Source	Comment
Referenced Image Sequence	0008,1140	SQ		ANAP	AUTO	
>Referenced SOP Class UID	0008,1150	UI		ALWAYS	AUTO	
>Referenced SOP Instance UID	0008,1155	UI		ALWAYS	AUTO	
Source Image Sequence	0008,2112	SQ		ANAP	AUTO	Only present

Attribute Name	Tag	VR	Value	Presence of Value	Source	Comment
						when DIN is configured
>Referenced SOP Class UID	0008,1150	UI		ALWAYS	AUTO	
>Referenced SOP Instance UID	0008,1155	UI		ALWAYS	AUTO	

Table 102: Image Plane Module

Attribute Name	Tag	VR	Value	Presence of Value	Source	Comment
Slice Thickness	0018,0050	DS		VNAP	AUTO	
Spacing Between Slices	0018,0088	DS		ANAP	AUTO	
Image Position (Patient)	0020,0032	DS		ALWAYS	AUTO	
Image Orientation (Patient)	0020,0037	DS		ALWAYS	AUTO	
Slice Location	0020,1041	DS		ANAP	AUTO	
Pixel Spacing	0028,0030	DS		ALWAYS	AUTO	

Table 103: Image Pixel Module

Attribute Name	Tag	VR	Value	Presence of Value	Source	Comment
Samples per Pixel	0028,0002	US	1	ALWAYS	FIXED	
Photometric Interpretation	0028,0004	CS	MONOCHROME2	ALWAYS	FIXED	
Rows	0028,0010	US		ALWAYS	AUTO	
Columns	0028,0011	US		ALWAYS	AUTO	
Bits Allocated	0028,0100	US	16	ALWAYS	FIXED	
Bits Stored	0028,0101	US	12	ALWAYS	FIXED	
High Bit	0028,0102	US	11	ALWAYS	FIXED	
Pixel Representation	0028,0103	US	0	ALWAYS	FIXED	
Pixel Data	7FE0,0010	OW/OB		ALWAYS	AUTO	

Table 104: Contrast/Bolus Module

Attribute Name	Tag	VR	Value	Presence of Value	Source	Comment
Contrast/Bolus Agent	0018,0010	LO		VNAP	AUTO	
Contrast/Bolus Route	0018,1040	LO		ANAP	AUTO	
Contrast/Bolus Volume	0018,1041	DS		ANAP	AUTO	
Contrast/Bolus Total Dose	0018,1044	DS		ANAP	AUTO	
Contrast Flow Rate	0018,1046	DS		ANAP	AUTO	
Contrast Flow Duration	0018,1047	DS		ANAP	AUTO	
Contrast/Bolus Ingredient Concentration	0018,1049	DS		ANAP	AUTO	

Table 105: CT Image Module

Attribute Name	Tag	VR	Value	Presence of Value	Source	Comment
Image Type	0008,0008	CS		ALWAYS	AUTO	
Scan Options	0018,0022	CS		ANAP	AUTO	
KVP	0018,0060	DS		VNAP	AUTO	
Filter Type	0018,1160	SH		ALWAYS	AUTO	
Data Collection Diameter	0018,0090	DS		ANAP	AUTO	
Reconstruction Diameter	0018,1100	DS		ANAP	AUTO	
Distance Source to Detector	0018,1110	DS		ANAP	AUTO	
Distance Source to Patient	0018,1111	DS		ANAP	AUTO	
Gantry/Detector Tilt	0018,1120	DS		ANAP	AUTO	
Table Height	0018,1130	DS		ANAP	AUTO	
Exposure Time	0018,1150	IS		ANAP	AUTO	
X-ray Tube Current	0018,1151	IS		ANAP	AUTO	
Exposure	0018,1152	IS		ANAP	AUTO	
Convolution Kernel	0018,1210	SH		ANAP	AUTO	
Revolution Time	0018,9305	FD		ANAP	AUTO	
Single Collimation Width	0018,9306	FD		ANAP	AUTO	
Total Collimation Width	0018,9307	FD		ANAP	AUTO	
Table Speed	0018,9309	FD		ANAP	AUTO	
Table Feed per Rotation	0018,9310	FD		ANAP	AUTO	
Spiral Pitch Factor	0018,9311	FD		ANAP	AUTO	
Reconstruction Target Center (Patient)	0018,9318	FD		ANAP	AUTO	
Exposure Modulation Type	0018,9323	CS		ANAP	AUTO	
Estimated Dose Saving	0018,9324	FD		ANAP	AUTO	
CTDIvol	0018,9345	FD		ANAP	AUTO	
CTDI Phantom Type Code Sequence	0018,9346	SQ		ANAP	AUTO	
>Code Value	0008,0100	SH		ALWAYS	AUTO	
>Coding Scheme Designator	0008,0102	SH		ALWAYS	AUTO	
>Coding Scheme Version	0008,0103	SH		ALWAYS	AUTO	
>Code Meaning	0008,0104	LO		ALWAYS	AUTO	
Acquisition Number	0020,0012	IS		VNAP	AUTO	
Samples per Pixel	0028,0002	US		ALWAYS	AUTO	
Photometric Interpretation	0028,0004	CS	MONOCHROME2	ALWAYS	AUTO	
Bits Allocated	0028,0100	US	16	ALWAYS	AUTO	
Bits Stored	0028,0101	US	12	ALWAYS	AUTO	
High Bit	0028,0102	US	11	ALWAYS	AUTO	
Rescale Intercept	0028,1052	DS	-1024	ALWAYS	FIXED	
Rescale Slope	0028,1053	DS	1	ALWAYS	FIXED	

Table 106: VOI LUT Module

Attribute Name	Tag	VR	Value	Presence of Value	Source	Comment
Window Center	0028,1050	DS		ALWAYS	AUTO	
Window Width	0028,1051	DS		ALWAYS	AUTO	

Table 107: SOP Common Module

Attribute Name	Tag	VR	Value	Presence of Value	Source	Comment
Specific Character Set	0008,0005	CS		ALWAYS	AUTO	
Instance Creation Date	0008,0012	DA		ANAP	AUTO	
Instance Creation Time	0008,0013	TM		ANAP	AUTO	
SOP Class UID	0008,0016	UI	1.2.840.10008.5.1.4.1.1.2	ALWAYS	AUTO	
SOP Instance UID	0008,0018	UI		ALWAYS	AUTO	
Instance Number	0020,0013	IS		ALWAYS	AUTO	

8.1.1.1.2 General ECG Waveform Storage SOP Class

Table 108: SOP Class Modules

Information Entity	Module	Presence
Patient	Patient Module	ALWAYS
Study	General Study Module	ALWAYS
	Patient Study Module	CONDITIONAL
Series	General Series Module	ALWAYS
Equipment	General Equipment Module	ALWAYS
Waveform	Waveform Identification Module	ALWAYS
	Waveform Module	ALWAYS
	Acquisition Context Module	ALWAYS
	SOP Common Module	ALWAYS

Table 109: Patient Module

Attribute Name	Tag	VR	Value	Presence of Value	Source	Comment
Patient's Name	0010,0010	PN		VNAP	USER	
Patient ID	0010,0020	LO		VNAP	USER	
Patient's Birth Date	0010,0030	DA		VNAP	USER	
Patient's Sex	0010,0040	CS		VNAP	USER	
Patient Comments	0010,4000	LT		ANAP	MWL, USER	
Referenced Patient Sequence	0008,1120	SQ		ANAP	MWL, USER	
>Referenced SOP Class UID	0008,1150	UI		ALWAYS	AUTO	
>Referenced SOP Instance UID	0008,1155	UI		ALWAYS	AUTO	

Table 110: General Study Module

Attribute Name	Tag	VR	Value	Presence of Value	Source	Comment
Study Date	0008,0020	DA		VNAP	AUTO	
Study Time	0008,0030	TM		VNAP	AUTO	
Accession Number	0008,0050	SH		VNAP	USER	
Referring Physician's Name	0008,0090	PN		VNAP	USER	
Study Description	0008,1030	LO		ANAP	USER	
Study Instance UID	0020,000D	UI		ALWAYS	AUTO	
Study ID	0020,0010	SH		VNAP	AUTO	
Referenced Study Sequence	0008,1110	SQ		VNAP	AUTO	

Table 111: Patient Study Module

Attribute Name	Tag	VR	Value	Presence of Value	Source	Comment
Admitting Diagnoses Description	0008,1080	LO		ANAP	MWL, USER	
Patient's Age	0010,1010	AS		ANAP	MWL, USER	
Patient's Size	0010,1020	DS		ANAP	MWL, USER	
Patient's Weight	0010,1030	DS		ANAP	MWL, USER	

Table 112: General Series Module

Attribute Name	Tag	VR	Value	Presence of Value	Source	Comment
Series Date	0008,0021	DA		ANAP	AUTO	
Series Time	0008,0031	TM		ANAP	AUTO	
Modality	0008,0060	CS	EKG	ALWAYS	AUTO	
Series Description	0008,103E	LO		ANAP	AUTO	
Operators' Name	0008,1070	PN		ANAP	USER	
Referenced Performed Procedure Step Sequence	0008,1111	SQ		ANAP	AUTO	
>Referenced SOP Class UID	0008,1150	UI		ALWAYS	AUTO	
>Referenced SOP Instance UID	0008,1155	UI		ALWAYS	AUTO	
Body Part Examined	0018,0015	CS		ANAP	AUTO	
Protocol Name	0018,1030	LO		ANAP	AUTO	
Patient Position	0018,5100	CS		ALWAYS	AUTO	
Series Instance UID	0020,000E	UI		ALWAYS	AUTO	
Series Number	0020,0011	IS		VNAP	AUTO	
Performed Procedure Step Start Date	0040,0244	DA		ANAP	AUTO	
Performed Procedure Step Start Time	0040,0245	TM		ANAP	AUTO	
Performed Procedure	0040,0253	SH		ANAP	AUTO	

Attribute Name	Tag	VR	Value	Presence of Value	Source	Comment
Step ID						
Performed Procedure Step Description	0040,0254	LO		ANAP	AUTO	
Performed Protocol Code Sequence	0040,0260	SQ		ANAP	AUTO	
>Code Value	0008,0100	SH		ALWAYS	AUTO	
>Coding Scheme Designator	0008,0102	SH		ALWAYS	AUTO	
>Code Meaning	0008,0104	LO		ALWAYS	AUTO	
Request Attributes Sequence	0040,0275	SQ		ANAP	AUTO	
>Requested Procedure Description	0032,1060	LO		ANAP	AUTO	
>Requested Procedure Code Sequence	0032,1064	SQ		ANAP	AUTO	
>>Code Value	0008,0100	SH		ALWAYS	AUTO	
>>Coding Scheme Designator	0008,0102	SH		ALWAYS	AUTO	
>>Code Meaning	0008,0104	LO		ALWAYS	AUTO	
>Scheduled Procedure Step Description	0040,0007	LO		ANAP	AUTO	
>Scheduled Protocol Code Sequence	0040,0008	SQ		ANAP	AUTO	
>Code Value	0008,0100	SH		ALWAYS	AUTO	
>Coding Scheme Designator	0008,0102	SH		ALWAYS	AUTO	
>Code Meaning	0008,0104	LO		ALWAYS	AUTO	
>Scheduled Procedure Step ID	0040,0009	SH		ANAP	AUTO	
>Requested Procedure ID	0040,1001	SH		ANAP	AUTO	
>Reason for the Requested Procedure	0040,1002	LO		ALWAYS	AUTO	
>Reason for Requested Procedure Code Sequence	0040,100A	SQ		ALWAYS	AUTO	
>>Code Value	0008,0100	SH		ALWAYS	AUTO	
>>Coding Scheme Designator	0008,0102	SH		ALWAYS	AUTO	
>>Code Meaning	0008,0104	LO		ALWAYS	AUTO	

Table 113: General Equipment Module

Attribute Name	Tag	VR	Value	Presence of Value	Source	Comment
Manufacturer	0008,0070	LO	Philips	VNAP	FIXED	
Institution Name	0008,0080	LO		ANAP	CONFIG	
Institution Address	0008,0081	ST		ANAP	CONFIG	

Station Name	0008,1010	SH		ANAP	CONFIG	
Institutional Department Name	0008,1040	LO		ANAP	CONFIG	
Manufacturer's Model Name	0008,1090	LO	iCT - iCT 256/CT 6000 iCT-SP - iCT SP	ANAP	FIXED	
Device Serial Number	0018,1000	LO		ANAP	CONFIG	
Software Version(s)	0018,1020	LO	4.1.10	ANAP	FIXED	

Table 114: Waveform Identification Module

Attribute Name	Tag	VR	Value	Presence of Value	Source	Comment
Content Date	0008,0023	DA		ALWAYS	AUTO	
Acquisition Date time	0008,002A	DT		ALWAYS	AUTO	
Content Time	0008,0033	TM		ALWAYS	AUTO	
Instance Number	0020,0013	IS		ALWAYS	AUTO	

Table 115: Waveform Module

Attribute Name	Tag	VR	Value	Presence of Value	Source	Comment
Waveform Sequence	5400,0100	SQ		ALWAYS	AUTO	
>Multiplex Group Time Offset	0018,1068	DS		ALWAYS	AUTO	
>Waveform Originality	003A,0004	CS		ALWAYS	AUTO	
>Number of Waveform Channels	003A,0005	US		ALWAYS	AUTO	
>Number of Waveform Samples	003A,0010	UL		ALWAYS	AUTO	
>Sampling Frequency	003A,001A	DS		ALWAYS	AUTO	
>Channel Definition Sequence	003A,0200	SQ		ALWAYS	AUTO	
>>Channel Source Sequence	003A,0208	SQ		ALWAYS	AUTO	
>>>Code Value	0008,0100	SH		ALWAYS	AUTO	
>>>Coding Scheme Designator	0008,0102	SH		ALWAYS	AUTO	
>>>Code Meaning	0008,0104	LO		ALWAYS	AUTO	
>>Channel Sample Skew	003A,0215	DS		ALWAYS	AUTO	
>>Waveform Bits Stored	003A,021A	US	8	ALWAYS	AUTO	
>Waveform Bits Allocated	5400,1004	US	16	ALWAYS	AUTO	
>Waveform Sample Interpretation	5400,1006	CS		ALWAYS	AUTO	
>Waveform Data	5400,1010	OW/OB		ALWAYS	AUTO	

Table 116: Acquisition Context Module

Attribute Name	Tag	VR	Value	Presence of Value	Source	Comment
Acquisition Context Sequence	0040,0555	SQ		VNAP	AUTO	

Table 117: SOP Common Module

Attribute Name	Tag	VR	Value	Presence of Value	Source	Comment
SOP Class UID	0008,0016	UI	1.2.840.10008.5.1.4.1.1.9.1.2	ALWAYS	FIXED	
SOP Instance UID	0008,0018	UI		ALWAYS	AUTO	
Instance Number	0020,0013	IS		ALWAYS	AUTO	

8.1.1.1.3 Secondary Capture Image Storage SOP Class

Table 118: SOP Class Modules

Information Entity	Module	Presence
Patient	Patient Module	ALWAYS
Study	General Study Module	ALWAYS
	Patient Study Module	CONDITIONAL
Series	General Series Module	ALWAYS
Equipment	SC Equipment Module	ALWAYS
	General Equipment Module	ALWAYS
Acquisition	General Acquisition Module	ALWAYS
Image	General Image Module	ALWAYS
	Image Pixel Module	ALWAYS
	SC Image Module	ALWAYS
	Modality LUT Module	CONDITIONAL
	VOI LUT Module	CONDITIONAL
	SOP Common Module	ALWAYS

Table 119: Patient Module

Attribute Name	Tag	VR	Value	Presence of Value	Source	Comment
Patient's Name	0010,0010	PN		VNAP	COPY	
Patient ID	0010,0020	LO		VNAP	COPY	
Patient's Birth Date	0010,0030	DA		VNAP	COPY	
Patient's Sex	0010,0040	CS		VNAP	COPY	
Patient Comments	0010,4000	LT		ANAP	MWL, USER	
Referenced Patient Sequence	0008,1120	SQ		ANAP	MWL, USER	
>Referenced SOP Class UID	0008,1150	UI		ALWAYS	AUTO	
>Referenced SOP Instance UID	0008,1155	UI		ALWAYS	AUTO	

Table 120: General Study Module

Attribute Name	Tag	VR	Value	Presence of Value	Source	Comment
Study Date	0008,0020	DA		VNAP	COPY	
Study Time	0008,0030	TM		VNAP	COPY	
Accession Number	0008,0050	SH		VNAP	COPY	
Referring Physician's Name	0008,0090	PN		VNAP	COPY	
Study Description	0008,1030	LO		ANAP	COPY	

Study Instance UID	0020,000D	UI		ALWAYS	COPY	
Study ID	0020,0010	SH		VNAP	COPY	
Referenced Study Sequence	0008,1110	SQ		VNAP	AUTO	

Table 121: Patient Study Module

Attribute Name	Tag	VR	Value	Presence of Value	Source	Comment
Admitting Diagnoses Description	0008,1080	LO		ANAP	MWL, USER	
Patient's Age	0010,1010	AS		ANAP	MWL, USER	
Patient's Size	0010,1020	DS		ANAP	MWL, USER	
Patient's Weight	0010,1030	DS		ANAP	MWL, USER	

Table 122: General Series Module

Attribute Name	Tag	VR	Value	Presence of Value	Source	Comment
Series Date	0008,0021	DA		ANAP	AUTO	
Series Time	0008,0031	TM		ANAP	AUTO	
Modality	0008,0060	CS	CT	ALWAYS	FIXED	
Series Description	0008,103E	LO		ANAP	AUTO	
Operators' Name	0008,1070	PN		ALWAYS	FIXED	
Referenced Performed Procedure Step Sequence	0008,1111	SQ		ANAP	AUTO	
>Referenced SOP Class UID	0008,1150	UI		ALWAYS	AUTO	
>Referenced SOP Instance UID	0008,1155	UI		ALWAYS	AUTO	
Body Part Examined	0018,0015	CS		ANAP	AUTO	
Protocol Name	0018,1030	LO		ANAP	AUTO	
Patient Position	0018,5100	CS		ANAP	AUTO	
Series Instance UID	0020,000E	UI		ALWAYS	AUTO	
Series Number	0020,0011	IS		ALWAYS	AUTO	
Request Attributes Sequence	0040,0275	SQ		ANAP	AUTO	
>Requested Procedure Description	0032,1060	LO		ANAP	AUTO	
>Requested Procedure Code Sequence	0032,1064	SQ		ANAP	AUTO	
>>Code Value	0008,0100	SH		ALWAYS	AUTO	
>>Coding Scheme Designator	0008,0102	SH		ALWAYS	AUTO	
>>Code Meaning	0008,0104	LO		ALWAYS	AUTO	
>Scheduled Procedure Step Description	0040,0007	LO		ANAP	AUTO	
>Scheduled Protocol Code Sequence	0040,0008	SQ		ANAP	AUTO	
>Code Value	0008,0100	SH		ALWAYS	AUTO	
>Coding Scheme	0008,0102	SH		ALWAYS	AUTO	

Attribute Name	Tag	VR	Value	Presence of Value	Source	Comment
Designator						
>Code Meaning	0008,0104	LO		ALWAYS	AUTO	
>Scheduled Procedure Step ID	0040,0009	SH		ANAP	AUTO	
>Requested Procedure ID	0040,1001	SH		ANAP	AUTO	
>Reason for the Requested Procedure	0040,1002	LO		ALWAYS	AUTO	
>Reason for Requested Procedure Code Sequence	0040,100A	SQ		ALWAYS	AUTO	
>>Code Value	0008,0100	SH		ALWAYS	AUTO	
>>Coding Scheme Designator	0008,0102	SH		ALWAYS	AUTO	
>>Code Meaning	0008,0104	LO		ALWAYS	AUTO	

Table 123: General Equipment Module

Attribute Name	Tag	VR	Value	Presence of Value	Source	Comment
Manufacturer	0008,0070	LO	Philips	VNAP	FIXED	
Institution Name	0008,0080	LO		ANAP	COPY	
Institution Address	0008,0081	ST		ANAP	COPY	
Station Name	0008,1010	SH		ANAP	COPY	
Institutional Department Name	0008,1040	LO		ANAP	COPY	
Manufacturer's Model Name	0008,1090	LO	iCT - iCT 256/CT 6000 iCT-SP - iCT SP	ANAP	FIXED	
Device Serial Number	0018,1000	LO		ANAP	COPY	
Software Version(s)	0018,1020	LO	4.1.10	ANAP	FIXED	

Table 124: SC Equipment Module

Attribute Name	Tag	VR	Value	Presence of Value	Source	Comment
Modality	0008,0060	CS	CT	ANAP	FIXED	
Conversion Type	0008,0064	CS	WSD	ALWAYS	AUTO	
Secondary Capture Device Manufacturer	0018,1016	LO	Philips	ANAP	FIXED	
Secondary Capture Device Manufacturer's Model Name	0018,1018	LO	iCT - iCT 256/CT 6000 iCT-SP - iCT SP	ANAP	FIXED	
Secondary Capture Device Software Version(s)	0018,1019	LO	4.1.10	ANAP	FIXED	

Table 125: General Acquisition Module

Attribute Name	Tag	VR	Value	Presence of Value	Source	Comment
Acquisition Date	0008,0022	DA		ANAP	AUTO	

Acquisition Time	0008,0032	TM		ANAP	AUTO	
Acquisition DateTime	0008,002A	DT		ANAP	AUTO	
Irradiation Event UID	0008,3010	UI		ANAP	AUTO	
Acquisition Number	0020,0012	IS		ANAP	AUTO	

Table 126: General Image Module

Attribute Name	Tag	VR	Value	Presence of Value	Source	Comment
Image Type	0008,0008	CS	Value 1: DERIVED, Value 2: SECONDARY	ANAP	AUTO	
Content Date	0008,0023	DA		VNAP	AUTO	
Content Time	0008,0033	TM		VNAP	AUTO	
Instance Number	0020,0013	IS		ALWAYS	AUTO	
Patient Orientation	0020,0020	CS		VNAP	AUTO	
Image Comments	0020,4000	LT		ANAP	AUTO	
Burned In Annotation	0028,0301	CS	NO	ANAP	AUTO	YES if patient information is burned in.
Lossy Image Compression	0028,2110	CS		ANAP	AUTO	

Table 127: Image Pixel Module

Attribute Name	Tag	VR	Value	Presence of Value	Source	Comment
Samples per Pixel	0028,0002	US	1 or 3	ALWAYS	AUTO	
Photometric Interpretation	0028,0004	CS	MONOCHROME2 or RGB	ALWAYS	AUTO	
Planar Configuration	0028,0006	US	1	ALWAYS	FIXED	
Rows	0028,0010	US	512	ALWAYS	AUTO	512 or more
Columns	0028,0011	US	512	ALWAYS	AUTO	
Bits Allocated	0028,0100	US	16 or 8	ALWAYS	AUTO	
Bits Stored	0028,0101	US	12 or 8	ALWAYS	AUTO	
High Bit	0028,0102	US	11 or 7	ALWAYS	AUTO	
Pixel Representation	0028,0103	US	0	ALWAYS	FIXED	
Pixel Data	7FE0,0010	OW/OB		ANAP	AUTO	

Table 128: SC Image Module

Attribute Name	Tag	VR	Value	Presence of Value	Source	Comment
Date of Secondary Capture	0018,1012	DA		ANAP	AUTO	
Time of Secondary Capture	0018,1014	TM		ANAP	AUTO	
Pixel Spacing	0028,0030	DS		ANAP	AUTO	

Table 129: Modality LUT Module

Attribute Name	Tag	VR	Value	Presence of Value	Source	Comment
Rescale Intercept	0028,1052	DS		ANAP	AUTO	
Rescale Slope	0028,1053	DS		ANAP	AUTO	
Rescale Type	0028,1054	LO		ANAP	AUTO	

Table 130: VOI LUT Module

Attribute Name	Tag	VR	Value	Presence of Value	Source	Comment
Window Center	0028,1050	DS		ANAP	AUTO	
Window Width	0028,1051	DS		ANAP	AUTO	

Table 131: SOP Common Module

Attribute Name	Tag	VR	Value	Presence of Value	Source	Comment
Specific Character Set	0008,0005	CS		ALWAYS	COPY	
Instance Creation Date	0008,0012	DA		ANAP	AUTO	
Instance Creation Time	0008,0013	TM		ANAP	AUTO	
SOP Class UID	0008,0016	UI	1.2.840.10008.5.1.4.1.1.7	ALWAYS	FIXED	
SOP Instance UID	0008,0018	UI		ALWAYS	AUTO	
Contributing Equipment Sequence	0018,A001	SQ		ANAP	AUTO	
>Manufacturer	0008,0070	LO	PHILIPS	ALWAYS	AUTO	
>Institution Name	0008,0080	LO		ANAP	AUTO	
>Institution Address	0008,0081	ST		ANAP	AUTO	
>Station Name	0008,1010	SH		ANAP	AUTO	
>Institutional Department Name	0008,1040	LO		ANAP	AUTO	
>Manufacturer's Model Name	0008,1090	LO	iCT - iCT 256/CT 6000 iCT-SP - iCT SP	ANAP	AUTO	
>Device Serial Number	0018,1000	LO		ANAP	AUTO	
>Software Version(s)	0018,1020	LO		ANAP	AUTO	
>Purpose of Reference Code Sequence	0040,A170	SQ		ALWAYS	AUTO	
>>Code Value	0008,0100	SH		ALWAYS	AUTO	
>>Coding Scheme Designator	0008,0102	SH		ALWAYS	AUTO	
>>Code Meaning	0008,0104	LO		ALWAYS	AUTO	
Instance Number	0020,0013	IS		ALWAYS	AUTO	

8.1.1.1.4 X-Ray Radiation Dose SR SOP Class

Table 132: SOP Class Modules

Information Entity	Module	Presence
Patient	Patient Module	ALWAYS
Study	General Study Module	ALWAYS

	Patient Study Module	CONDITIONAL
Series	SR Document Series Module	ALWAYS
Equipment	General Equipment Module	ALWAYS
	Enhanced General Equipment Module	ALWAYS
Image	SR Document General Module	ALWAYS
	SR Document Content Module	ALWAYS
	SOP Common Module	ALWAYS

Table 133: Patient Module

Attribute Name	Tag	VR	Value	Presence of Value	Source	Comment
Patient's Name	0010,0010	PN		VNAP	COPY	
Patient ID	0010,0020	LO		VNAP	COPY	
Patient's Birth Date	0010,0030	DA		VNAP	COPY	
Patient's Sex	0010,0040	CS		VNAP	COPY	
Patient Comments	0010,4000	LT		ANAP	MWL, USER	
Referenced Patient Sequence	0008,1120	SQ		ANAP	MWL, USER	
>Referenced SOP Class UID	0008,1150	UI		ALWAYS	AUTO	
>Referenced SOP Instance UID	0008,1155	UI		ALWAYS	AUTO	

Table 134: General Study Module

Attribute Name	Tag	VR	Value	Presence of Value	Source	Comment
Study Date	0008,0020	DA		VNAP	COPY	
Study Time	0008,0030	TM		VNAP	COPY	
Accession Number	0008,0050	SH		VNAP	COPY	
Referring Physician's Name	0008,0090	PN		VNAP	COPY	
Study Description	0008,1030	LO		ANAP	COPY	
Study Instance UID	0020,000D	UI		ALWAYS	COPY	
Study ID	0020,0010	SH		VNAP	COPY	
Referenced Study Sequence	0008,1110	SQ		ANAP	AUTO	Shall be present with Zero or more items
>Referenced SOP Class UID	0008,1150	UI		ALWAYS	AUTO	
>Referenced SOP Instance UID	0008,1155	UI		ALWAYS	AUTO	

Table 135: Patient Study Module

Attribute Name	Tag	VR	Value	Presence of Value	Source	Comment
Admitting Diagnoses Description	0008,1080	LO		ANAP	MWL, USER	
Patient's Age	0010,1010	AS		ANAP	MWL, USER	

Patient's Size	0010,1020	DS		ANAP	MWL, USER	
Patient's Weight	0010,1030	DS		ANAP	MWL, USER	

Table 136: SR Document Series Module

Attribute Name	Tag	VR	Value	Presence of Value	Source	Comment
Series Date	0008,0021	DA		ANAP	COPY	
Series Time	0008,0031	TM		ANAP	COPY	
Modality	0008,0060	CS	SR	ALWAYS	FIXED	
Series Description	0008,103E	LO	Radiation Dose Information	ANAP	FIXED	
Referenced Performed Procedure Step Sequence	0008,1111	SQ		VNAP	AUTO	
>Referenced SOP Class UID	0008,1150	UI		ALWAYS	AUTO	
>Referenced SOP Instance UID	0008,1155	UI		ALWAYS	AUTO	
Series Instance UID	0020,000E	UI		ALWAYS	AUTO	
Series Number	0020,0011	IS	5000	ALWAYS	FIXED	

Table 137: General Equipment Module

Attribute Name	Tag	VR	Value	Presence of Value	Source	Comment
Manufacturer	0008,0070	LO	Philips	VNAP	COPY	
Institution Name	0008,0080	LO		ANAP	COPY	
Institution Address	0008,0081	ST		ANAP	COPY	
Station Name	0008,1010	SH		ANAP	COPY	
Institutional Department Name	0008,1040	LO		ANAP	COPY	
Manufacturer's Model Name	0008,1090	LO	iCT - iCT 256/CT 6000 iCT-SP - iCT SP	ANAP	FIXED	
Device Serial Number	0018,1000	LO		ANAP	COPY	
Software Version(s)	0018,1020	LO	4.1.10	ANAP	FIXED	

Table 138: Enhanced General Equipment Module

Attribute Name	Tag	VR	Value	Presence of Value	Source	Comment
Manufacturer	0008,0070	LO	Philips	ALWAYS	AUTO	
Manufacturer's Model Name	0008,1090	LO	iCT - iCT 256/CT 6000 iCT-SP - iCT SP	ALWAYS	FIXED	
Device Serial Number	0018,1000	LO		ALWAYS	AUTO	
Software Version(s)	0018,1020	LO	4.1.10	ALWAYS	FIXED	

Table 139: SR Document General Module

Attribute Name	Tag	VR	Value	Presence of Value	Source	Comment
Content Date	0008,0023	DA		ALWAYS	AUTO	
Content Time	0008,0033	TM		ALWAYS	AUTO	
Instance Number	0020,0013	IS	1	ALWAYS	FIXED	
Referenced Request Sequence	0040,A370	SQ		ALWAYS	AUTO	
>Reason for the Requested Procedure	0040,1002	LO		ALWAYS	AUTO	
>Reason for Requested Procedure Code Sequence	0040,100A	SQ		ALWAYS	AUTO	
>>Code Value	0008,0100	SH		ALWAYS	AUTO	
>>Coding Scheme Designator	0008,0102	SH		ALWAYS	AUTO	
>>Code Meaning	0008,0104	LO		ALWAYS	AUTO	
Performed Procedure Code Sequence	0040,A372	SQ		VNAP	AUTO	
Completion Flag	0040,A491	CS	COMPLETE	ALWAYS	FIXED	
Verification Flag	0040,A493	CS	UNVERIFIED	ALWAYS	FIXED	

Table 140: SR Document Content Module

Attribute Name	Tag	VR	Value	Presence of Value	Source	Comment
Value Type	0040,A040	CS	CONTAINER	ALWAYS	FIXED	
Concept Name Code Sequence	0040,A043	SQ		ANAP	AUTO	
>Code Value	0008,0100	SH		ALWAYS	AUTO	
>Coding Scheme Designator	0008,0102	SH		ALWAYS	AUTO	
>Code Meaning	0008,0104	LO		ALWAYS	AUTO	
Continuity Of Content	0040,A050	CS		ALWAYS	AUTO	
Content Template Sequence	0040,A504	SQ		ANAP	AUTO	
>Template Identifier	0040,DB00	CS		ALWAYS	AUTO	
>Mapping Resource	0008,0105	CS		ALWAYS	AUTO	
Content Sequence	0040,A730	SQ		ANAP	AUTO	
>Relationship Type	0040,A010	CS		ALWAYS	AUTO	

Table 141: SOP Common Module

Attribute Name	Tag	VR	Value	Presence of Value	Source	Comment
Specific Character Set	0008,0005	CS		ALWAYS	COPY	
Instance Creation Date	0008,0012	DA		ANAP	COPY	
Instance Creation Time	0008,0013	TM		ANAP	COPY	
SOP Class UID	0008,0016	UI	1.2.840.10008.5.1.4.1.1.88.67	ALWAYS	FIXED	

Attribute Name	Tag	VR	Value	Presence of Value	Source	Comment
SOP Instance UID	0008,0018	UI		ALWAYS	COPY	
Contributing Equipment Sequence	0018,A001	SQ		ANAP	AUTO	
>Manufacturer	0008,0070	LO		ALWAYS	AUTO	
>Institution Name	0008,0080	LO		ANAP	AUTO	
>Institution Address	0008,0081	ST		ANAP	AUTO	
>Station Name	0008,1010	SH		ANAP	AUTO	
>Institutional Department Name	0008,1040	LO		ANAP	AUTO	
>Manufacturer's Model Name	0008,1090	LO	iCT - iCT 256/CT 6000 iCT-SP - iCT SP	ANAP	AUTO	
>Device Serial Number	0018,1000	LO		ANAP	AUTO	
>Software Version(s)	0018,1020	LO		ANAP	AUTO	
>Purpose of Reference Code Sequence	0040,A170	SQ		ALWAYS	AUTO	
>>Code Value	0008,0100	SH		ALWAYS	AUTO	
>>Coding Scheme Designator	0008,0102	SH		ALWAYS	AUTO	
>>Code Meaning	0008,0104	LO		ALWAYS	AUTO	
Instance Number	0020,0013	IS		ANAP	AUTO	

8.1.2. Usage of Attributes from Received IOD

The following attributes shall be present in the received IODs in order to be accepted.

For all IODs

- SOP Class UID (0008,0016)
- Study Instance UID (0020,000D)
- Series Instance UID (0020,000E)

For Image IODs

- Pixel Data (7FE0,0010) - Size may not be 0.
- Bits Allocated (0028,0100)

8.1.3. Attribute Mapping

Not Applicable. Attribute mapping not claimed by the product.

8.1.4. Coerced/Modified fields

The Import/Export Transparency of DICOM objects means preserving the attributes' values of the objects imported from an external system (remote or removable), optionally processed and then exported to an external system.

The system complies with Level-2 requirements for Storage SCP as defined in DICOM PS 3.4 Appendix B4.1. In other words, all Type 1, Type 2, and Type 3 Attributes defined in the Information Object Definition (IOD) associated with the SOP Class, as well as any Standard Extended attributes (including Private Attributes) included in the SOP Instance, will be stored and may be accessed.

The system does not coerce any Data Elements, except those defined in the DICOM PS 3.4 Appendix B4.1. In other words, when a DICOM object is imported from another system and later exported, all the attributes values will remain unchanged.

In the received IODs, the following attributes may be modified under certain conditions.

Table 142: Modified Attributes

Attribute	Tag	When Modified
Patient's Name	0010,0010	If Empty, the Patient's Name will be set to "Unknown".
Patient ID	0010,0020	If Empty, the Patient ID will be set to "Unknown".
Rows	0028,0010	Is Fixed, if rows columns does not match pixel data size.
SOP Instance UID	0008,0018	If missing, a new SOP Instance UID will be generate by iCT, iCT-SP.

8.2. Data Dictionary of Private Attributes

These are defined in Section 8.5.1 in the specific objects.

8.3. Coded Terminology and Templates

8.3.1. Context Groups

Not Applicable. Context Groups are not implementd by the system.

8.3.2. Template Specifications

8.3.2.1. CT RADIATION DOSE SR IOD TEMPLATES

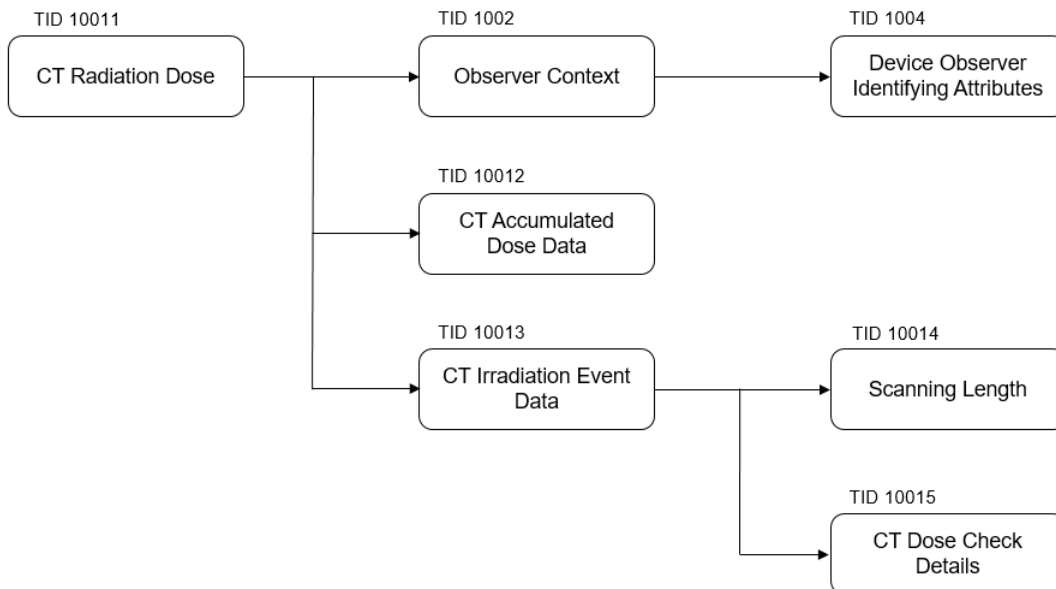

Figure 21: CT Radiation Dose SR IOD Template Structure

This section describes the content of all the templates used in the CT Radiation Dose Reporting SR.

Table 143: Used Templates for CT Radiation Dose Reporting

Template Name	Template ID
CT Radiation Dose	TID 10011

Template Name	Template ID
CT Accumulated Dose Data	TID 10012
CT Irradiation Event Data	TID 10013
Scanning Length	TID 10014
CT Dose Check Details	TID 10015
Observer Context	TID 1002
Device Observer Identifying Attributes	TID 1004

8.3.2.1.1 TID 10011 CT Radiation Dose

Table 144: CT Radiation Dose

NL	Relation with Parent	Concept Name	VT	VM	Presence of Value	Value
		EV (113701, DCM, X-Ray Radiation Dose Report)	CONTAINER	1	ALWAYS	
>	HAS CONCEPT MOD	EV (121058, DCM, Procedure reported)	CODE	1	ALWAYS	P5-08000, SRT, Computed Tomography X-Ray
>>	HAS CONCEPT MOD	EV (G-C0E8, SRT, Has Intent)	CODE	1	ALWAYS	R-408C3, SRT, Diagnostic Intent
>		DTID (1002) Observer Context	INCLUDE	1	ALWAYS	
>	HAS OBS CONTEXT	EV (113809, DCM, Start of X-Ray Irradiation)	DATE/TIME	1	ALWAYS	
>	HAS OBS CONTEXT	EV (113810, DCM, End of X-Ray Irradiation)	DATE/TIME	1	ALWAYS	
>	HAS OBS CONTEXT	EV (113705, DCM, Scope of Accumulation)	CODE	1	ALWAYS	113014, DCM, "Study"
>>	HAS PROPERTIES	DCID (10001) UID Types	UIDREF	1	ALWAYS	Study Instance UID (0020,000D)
>	CONTAINS	DTID (10012) CT Accumulated Dose Data	INCLUDE	1	ALWAYS	
>	CONTAINS	DTID (10013) CT Irradiation Event Data	INCLUDE	1-n	ALWAYS	
>	CONTAINS	EV (113854, DCM, "Source of Dose Information")	CODE	1	ALWAYS	113856, DCM, "Automated Data Collection"

8.3.2.1.2 TID 10012 CT Accumulated Dose

Table 145: CT Accumulated Dose

NL	Relation with Parent	Concept Name	VT	VM	Presence of Value	Value
		EV (113811, DCM, "CT Accumulated Dose Data")	CONTAINER	1	ALWAYS	

NL	Relation with Parent	Concept Name	VT	VM	Presence of Value	Value
>	CONTAINS	EV (113812, DCM, Total Number of Irradiation Events)	NUM	1	ALWAYS	
>	CONTAINS	EV (113813, DCM, CT Dose Length Product Total)	NUM	1	ALWAYS	

8.3.2.1.3 TID 10013 CT Irradiation Event Data

Table 146: CT Irradiation Event Data

NL	Relation with Parent	Concept Name	VT	VM	Presence of Value	Value
		EV (113819, DCM, "CT Acquisition")	CONTAINER	1	ALWAYS	
>	CONTAINS	EV (125203, DCM, "Acquisition Protocol")	TEXT	1	ALWAYS	Protocol Name (0018,1030)
>	CONTAINS	EV (123014, DCM, "Target Region")	CODE	1	ALWAYS	Scan Type / Organ Type
>	CONTAINS	EV (113820, DCM, "CT Acquisition Type")	CODE	1	ALWAYS	Acquisition Type: Constant Angle Acquisition
>	CONTAINS	EV (G-C32C, SRT, "Procedure Context")	CODE	1	ALWAYS	"Diagnostic radiography with contrast media " or "CT without contrast"
>	CONTAINS	EV (113769, DCM, "Irradiation Event UID")	UIDREF	1	ALWAYS	Identical to Irradiation Event UID in the images (0008,3010)
>	CONTAINS	EV (113822, DCM, "CT Acquisition Parameters")	CONTAINER	1	ALWAYS	
>>	CONTAINS	EV (113824, DCM, "Exposure Time")	NUM	1	ALWAYS	Value = Exposure Time (0018, 1150) - per scan. (units = s)
>>	CONTAINS	DTID 10014 : Scanning Length	INCLUDE	1	ALWAYS	Value = Scan Length (0018,1302) - per scan (units = mm)
>>	CONTAINS	EV (113826, DCM, "Nominal Single Collimation Width")	NUM	1	ALWAYS	The width of a single row of acquired data Value = Single Collimation Width(0018,9306) - per scan (units = mm)

>>	CONTAINS	EV (113827, DCM, "Nominal Total Collimation Width")	NUM	1	ALWAYS	The width of the total collimation over the area of active x-ray detection Value = Total Collimation Width(0018,9307) - per scan (units = mm)
>>	CONTAINS	EV (113828, DCM, "Pitch Factor")	NUM	1	CONDITIONAL	UNITS = EV ({ratio}, UCUM, "ratio")
>>	CONTAINS	EV (113823, DCM, "Number of X-Ray Sources")	NUM	1	ALWAYS	1
>>	CONTAINS	EV (113831, DCM, "CT X-Ray Source Parameters")	CONTAINER	1	ALWAYS	
>>>	CONTAINS	EV (113832, DCM, "Identification of the X-Ray Source")	TEXT	1	ALWAYS	A
>>>	CONTAINS	EV (113733, DCM, "KVP")	NUM	1	ALWAYS	Same as KVP (0018,0060) - per scan Units = kV
>>>	CONTAINS	EV (113833, DCM, "Maximum X-Ray Tube Current")	NUM	1	ALWAYS	Value = Max X-ray Tube Current (01E1, 1052) - per scan. Units = mA
>>>	CONTAINS	EV (113734, DCM, "X-Ray Tube Current")	NUM	1	ALWAYS	Value = X-ray Tube Current(0018,1151) - per scan Units = mA
>>>	CONTAINS	EV (113834, DCM, "Exposure Time per Rotation")	NUM	1	CONDITIONAL	UNITS = EV (s, UCUM, "s")
>	CONTAINS	EV (113829, DCM, "CT Dose")	CONTAINER	1	CONDITIONAL	IF EV (113820, DCM, "CT Acquisition Type") does not equal (113805, DCM, "Constant Angle Acquisition")
>>	CONTAINS	EV (113830, DCM, "Mean CTDIvol")	NUM	1	ALWAYS	Value = CTDIVol (0018,9345) - per scan Units = mGy
>>	CONTAINS	EV (113835, DCM, "CTDIw Phantom Type")	CODE	1	ALWAYS	Value = "IEC Head Dosimetry Phantom " for 16cm Head phantom Value = "IEC Body Dosimetry Phantom " for 32cm Body phantom

>>	CONTAINS	EV (113838, DCM, "DLP")	NUM	1	ALWAYS	Value = DLP (00E1, 1021) - per scan (+/- 2% is acceptable). Units = mGy*cm
>>	CONTAINS	EV (113930, DCM, "Size Specific Dose Estimation")	NUM	1-n	CONDITIONAL	UNITS = EV (mGy, UCUM, "mGy")
>>>	HAS CONCEPT MOD	EV (G-C036, SRT, "Measurement Method")	CODE	1	ALWAYS	
>>> >	INFERRED FROM	EV (113985, DCM, "Series or Instance used for Water Equivalent Diameter estimation")	UIDREF	1-n	CONDITIONAL	IF (113984, DCM, "Water Equivalent Diameter From Localizer")
>>	CONTAINS	DTID (10015) CT Dose Check Details	INCLUDE	1	ALWAYS	

8.3.2.1.4 TID 1002 Observer Context

Table 147: Observer Context

NL	Relation with Parent	Concept Name	VT	VM	Presence of Value	Value
>	HAS OBS CONTEXT	EV (121005, DCM, Observer Type)	CODE	1	CONDITIONAL	(121007, DCM, Device)
>	HAS OBS CONTEXT	DTID (1004) Device observer identifying attributes	INCLUDE	1	ALWAYS	

8.3.2.1.5 TID 1004 Device Observer Identifying Attributes

Table 148: Device Observer Identifying Attributes

NL	Relation with Parent	Concept Name	VT	VM	Presence of Value	Value
>	HAS OBS CONTEXT	EV (121012, DCM, Device Observer UID)	UIDREF	1	ALWAYS	Concatenation of Philips CT Root (1.3.46.670589.33.1) and Network Board MAC address
>	HAS OBS CONTEXT	EV (121013, DCM, Device Observer Name)	TEXT	1	CONDITIONAL	Station Name (0008,1010): Equals the computer name (under Start->System Settings)
>	HAS OBS CONTEXT	EV (121014, DCM, Device Observer Manufacturer)	TEXT	1	CONDITIONAL	Manufacturer (0008,0070): Philips
>	HAS OBS CONTEXT	EV (121015, DCM, Device Observer Model Name)	TEXT	1	CONDITIONAL	Manufacturer's Model Name (0008,1090): iCT - iCT 256/CT 6000 iCT-SP - iCT SP
>	HAS OBS CONTEXT	EV (121016, DCM, Device Observer Serial Number)	TEXT	1	CONDITIONAL	Device Serial Number (0018,1000) As in Preferences -> Institute -> Product Serial Number

>	HAS OBS CONTEXT	EV(121017, DCM, Device Observer Physical Location During Observation	TEXT	1	CONDITIONAL	Institution Name (0008,0080): As in Preferences -> Institute -> Name
---	-----------------	--	------	---	-------------	---

8.3.2.1.6 TID 10014 Scanning Length

Table 149: Scanning Length

NL	Relation with Parent	Concept Name	VT	VM	Presence of Value	Value
	CONTAINS	EV (113825, DCM, "Scanning Length")	NUM	1	ALWAYS	(mm, UCUM, mm)

8.3.2.1.7 TID 10015 CT Dose Check Details

Table 150: CT Dose Check Details

NL	Relation with Parent	Concept Name	VT	VM	Presence of Value	Value
		EV (113900, DCM, "Dose Check Alert Details")	CONTAINER	1	ALWAYS	
>	CONTAINS	EV (113901, DCM, DLP Alert Value Configured)	CODE	1	ALWAYS	Yes/No Value depends on whether the relevant (head/body) DLP Alert value is set in preferences.
>	CONTAINS	EV (113902, DCM, CTDIvol Alert Value Configured)	CODE	1	ALWAYS	Yes/No Value depends on whether the relevant (head/body) CTDIvol Alert value is set in preferences.
>	CONTAINS	EV (113904, DCM, CTDIvol Alert Value)	NUM	1	CONDITIONAL	(mGy, UCUM, mGy)
		EV (113908, DCM, Dose Check Notification Details)	CONTAINER	1	CONDITIONAL	
>	CONTAINS	EV (113909, DCM, "DLP Notification Value Configured")	CODE	1	ALWAYS	Yes/No Value depends on whether a DLP Notification value was set in the protocol step.
>	CONTAINS	EV (113910, DCM, "CTDIvol Notification Value Configured")	CODE	1	ALWAYS	Value depends on whether a CTDIvol Notification value was set in the protocol step.

>	CONTAINS	EV (113912, DCM, "CTDivol Notification Value")	NUM	1	CONDITIONAL	
---	----------	--	-----	---	-------------	--

8.3.3. Private code definitions

Not Applicable. Private code definitions are not implemented by the system.

8.4. Grayscale Image consistency

Not Applicable. Grayscale Image consistency is not claimed by the system.s

8.5. Standard Extended/Specialized/Private SOPs

Table 151: List of created SOP Classes

SOP Class Name	SOP Class UID
CT Image Storage SOP Class	1.2.840.10008.5.1.4.1.1.2
Secondary Capture Image Storage SOP Class	1.2.840.10008.5.1.4.1.1.7
General ECG Waveform Storage SOP Class	1.2.840.10008.5.1.4.1.1.9.1.2
X-Ray Radiation Dose SR	1.2.840.10008.5.1.4.1.1.88.67

8.5.1. Standard Extended/Specialized/Private SOP Instance

This section describes (particular) Standard Extended SOP Classes, Specialized SOP Classes, or Private SOP Classes that are used.

8.5.1.1. CT Image Storage SOP Class

Table 152: Extended DICOM and private attributes for CT Image Storage SOP Class Instances

Attribute Name	Tag	VR	Value	Presence of Value	Source	Comment
Angular Position (retired)	0018,1141	DS		ALWAYS	AUTO	
Acquisition Type	0018,9302	CS		ALWAYS	AUTO	
Slice Progression Direction	0054,0500	CS		ALWAYS	AUTO	
Units	0054,1001	CS		ALWAYS	AUTO	

8.5.1.2. Secondary Capture Image Storage SOP Class

Table 153: Extended DICOM and private attributes for Secondary Capture Image Storage SOP Class Instances

Attribute Name	Tag	VR	Value	Presence of Value	Source	Comment
Medical Alerts	0010,2000	LO		VNAP	COPY	
Allergies	0010,2110	LO		VNAP	COPY	
Pregnancy Status	0010,21C0	US		VNAP	COPY	
Scan Options	0018,0022	CS		ANAP	COPY	
Slice Thickness	0018,0050	DS		ANAP	COPY	
KVP	0018,0060	DS		ANAP	COPY	
Data Collection Diameter	0018,0090	DS		ANAP	COPY	

Attribute Name	Tag	VR	Value	Presence of Value	Source	Comment
Reconstruction Diameter	0018,1100	DS		ANAP	COPY	
Distance Source to Detector	0018,1110	DS		ANAP	COPY	
Distance Source to Patient	0018,1111	DS		ANAP	COPY	
Gantry/Detector Tilt	0018,1120	DS		ANAP	COPY	
Table Height	0018,1130	DS		ANAP	COPY	
Angular Position (retired)	0018,1141	DS		ANAP	COPY	
Exposure Time	0018,1150	IS		ANAP	COPY	
X-ray Tube Current	0018,1151	IS		ANAP	COPY	
Acquisition Type	0018,9302	CS		ANAP	COPY	
Single Collimation Width	0018,9306	FD		ANAP	COPY	
Total Collimation Width	0018,9307	FD		ANAP	COPY	
Table Speed	0018,9309	FD		ANAP	COPY	
Exposure Modulation Type	0018,9323	CS		ANAP	COPY	
Estimated Dose Saving	0018,9324	FD		ANAP	COPY	
Requesting Physician	0032,1032	PN		VNAP	COPY	
Special Needs	0038,0050	LO		VNAP	COPY	
Patient State	0038,0500	LO		VNAP	COPY	
Total Number of Exposures	0040,0301	US		ANAP	COPY	
Exposure Dose Sequence	0040,030E	SQ		ANAP	COPY	
>Acquisition Date time	0008,002A	DT		ANAP	COPY	
>Series Description	0008,103E	LO		ANAP	COPY	
>Contrast/Bolus Agent	0018,0010	LO		ANAP	COPY	
>Body Part Examined	0018,0015	CS		ANAP	COPY	
>KVP	0018,0060	DS		ANAP	COPY	
>Protocol Name	0018,1030	LO		ANAP	COPY	
>Exposure Time	0018,1150	IS		ANAP	COPY	
>X-ray Tube Current	0018,1151	IS		ANAP	COPY	
>Exposure	0018,1152	IS		ANAP	COPY	
>Radiation Mode	0018,115A	CS		ANAP	COPY	
>Scan Length	0018,1302	IS		ANAP	COPY	
>Acquisition Duration	0018,9073	FD		ANAP	COPY	
>Acquisition Type	0018,9302	CS		ANAP	COPY	
>Single Collimation Width	0018,9306	FD		ANAP	COPY	
>Total Collimation Width	0018,9307	FD		ANAP	COPY	
>CTDIvol	0018,9345	FD		ANAP	COPY	
>Series Number	0020,0011	IS		ANAP	COPY	

Attribute Name	Tag	VR	Value	Presence of Value	Source	Comment
>Comments on Radiation Dose	0040,0310	ST		ANAP	COPY	
Comments on Radiation Dose	0040,0310	ST		ANAP	COPY	

8.5.1.3. General ECG Waveform Storage SOP Class

Table 154: Extended DICOM and private attributes for General ECG Waveform Storage SOP Class Instances

Attribute Name	Tag	VR	Value	Presence of Value	Source	Comment
Frame of Reference UID	0020,0052	UI		ANAP	AUTO	
Position Reference Indicator	0020,1040	LO		ALWAYS	AUTO	
Image Comments	0020,4000	LT		ALWAYS	AUTO	

8.5.1.4. X-Ray Radiation Dose SR SOP Class

Extended DICOM and Private Attributes are not applicable for this SOP class instance.

8.6. Private Transfer Syntaxes

Supported Private Transfer Syntaxes are shown in the next Table.

Table 155: Supported Private Transfer Syntaxes

Transfer Syntax Name	Transfer Syntax UID	Comment
Private CT Transfer Syntax - Explicit VR Little Endian	1.3.46.670589.33.1.4.1	Private ELE (P-ELE).

- This part of the page is left intentionally empty -

Issued by:

Philips Medical Systems Nederland B.V., a Philips Healthcare company,
P.O. Box 10.000
5680 DA Best
The Netherlands

Internet: <https://www.philips.com/dicom>

Doc Id: HSDP-681264

Date: 18-DEC-2024

